

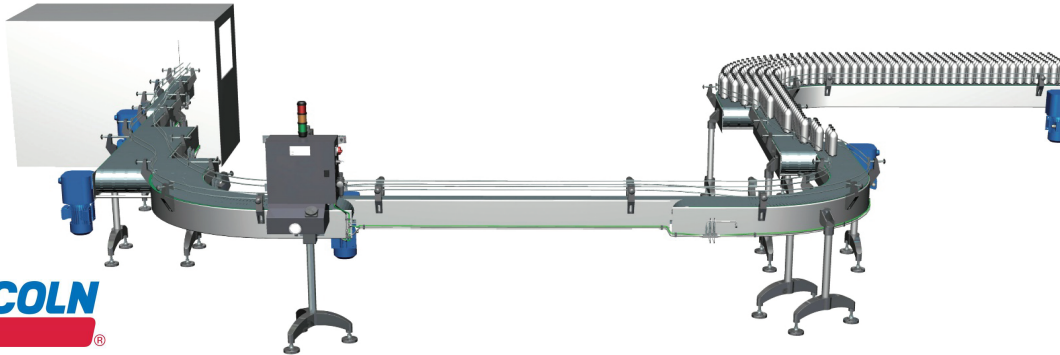

INDUSTRIAL AUTOMATIC LUBRICATION

The right lubricant, in the right quantity, at the right time, to the right lubrication point



COMPREHENSIVE PORTFOLIO of AUTOMATED DISPENSING SYSTEMS for LUBRICANT, INK, ADHESIVE & SEALANT APPLICATIONS

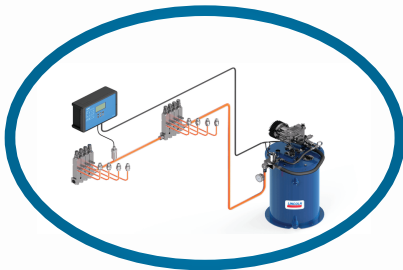

Single-line Lubrication Systems

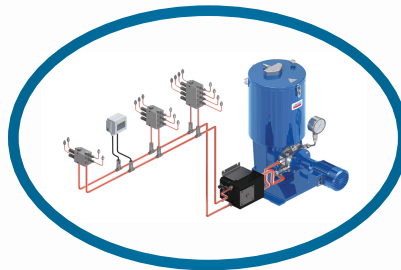

Dual-line Lubrication Systems

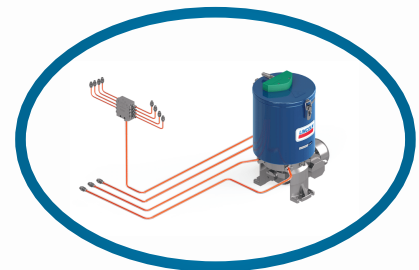

Multi-line Lubrication Systems

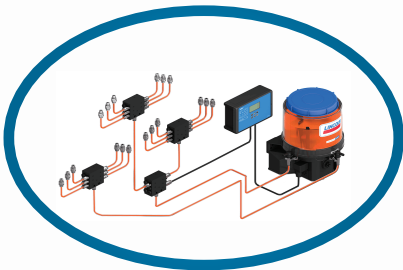

Progressive Lubrication Systems

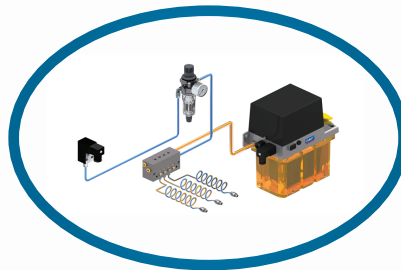

Oil and Air Lubrication Systems

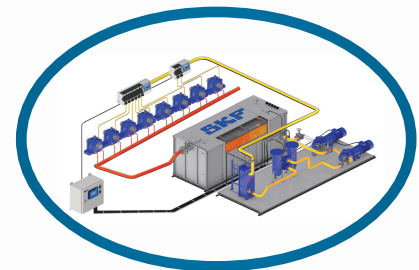

Oil Circulating Systems

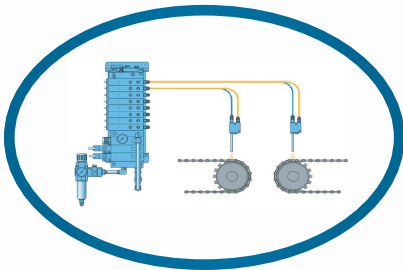

ORSCO Chain Lubrication

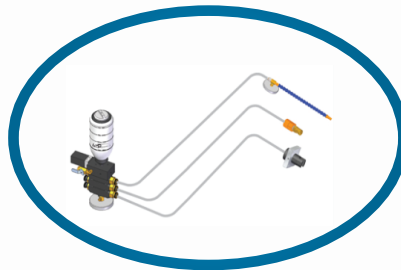

MQL & Microdosing

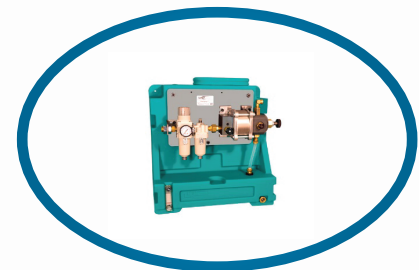

LSP Die Spray Lubrication

System Design • Installation • Service • Repairs



General Industrial - Production and assembly plants, integrated work cells, steel mills, injection molders, pulp & paper, presses, stamping, printers and more

Food & Beverage - Bottling, canning, meat & poultry processing, bakeries, pharmaceuticals, and more

Packaging - Palletizers, stretch wrappers, labelers, air-bubble wrapping systems, flexible packaging systems, laminated packaging systems, stackers, carton formers and more

Wind Energy / Oil & Gas - New & retrofit system solutions

Lubrication Tools & Equipment



Parker Store

FLUID CONNECTORS

- Brass fittings & valves
- Diagnostic equipment
- Hose couplings
- Industrial Hose
- PTFE hose & tubing
- Quick couplings
- Rubber & thermoplastic hose
- Tube fittings & adapters
- Tubing & plastic fittings
- Tubing & hose assembly equipment



SERVICES

- Stocking distributor
- System analysis and design
- System installation and start-up
- Service and repair
- Training or consulting

