

1/2021

AC30 Variable Speed Drive

AC30V, AC30P, and AC30D

Three Performance Levels to Suit a Wide Range of Applications

1 - 650 HP (0.75 - 450 kW)



ENGINEERING YOUR SUCCESS.

 **WARNING - USER RESPONSIBILITY**

FAILURE OR IMPROPER SELECTION OR IMPROPER USE OF THE PRODUCTS DESCRIBED HEREIN OR RELATED ITEMS CAN CAUSE DEATH, PERSONAL INJURY AND PROPERTY DAMAGE.

This document and other information from Parker Hannifin Corporation, its subsidiaries and authorized distributors provide product or system options for further investigation by users having technical expertise.

The user, through its own analysis and testing, is solely responsible for making the final selection of the system and components and assuring that all performance, endurance, maintenance, safety and warning requirements of the application are met. The user must analyze all aspects of the application, follow applicable industry standards, and follow the information concerning the product in the current product catalog and in any other materials provided from Parker or its subsidiaries or authorized distributors.

To the extent that Parker or its subsidiaries or authorized distributors provide component or system options based upon data or specifications provided by the user, the user is responsible for determining that such data and specifications are suitable and sufficient for all applications and reasonably foreseeable uses of the components or systems.

OFFER OF SALE

The items described in this document are hereby offered for sale by Parker Hannifin Corporation, its subsidiaries or its authorized distributors. This offer and its acceptance by the provisions stated in the detailed 'Offer of Sale' which is available upon request.

 **WARNING**

This product may contain a chemical known to the State of California to cause cancer, or birth defects or other reproductive harm. For more information go to www.P65Warnings.ca.gov.

AC30 - Three Performance Levels to Suit a Wide Range of Applications

Overview	5
Technical Specifications.....	9
Connectivity.....	9
Specifications.....	11
Dimensions	13
Connections	14
Accessories and Options	17
Operator Keypad	17
Line Reactors, Filters, and Braking Resistors	17
Communication Interfaces	18
Input and Output Cards.....	19
Order Code.....	22
AC30 Variable Speed Drive, Accessories	22
Software	23
DSELite and Parker Drive Quicktool (PDQ)	25
Where to Buy	24

Parker Hannifin

The global leader in motion and control technologies and systems

Global Partnerships Global Support

Parker is committed to helping make our customers more productive and more profitable through our global offering of motion and control products and systems. In an increasingly competitive global economy, we seek to develop customer relationships as technology partnerships. Working closely with our customers, we can ensure the best selection of technologies to suit the needs of our customers' applications.

Electromechanical Technologies for High Dynamic Performance and Precision Motion

Parker electromechanical technologies form an important part of Parker's global motion and control offering. Electromechanical systems combine high performance speed and position control with the flexibility to adapt the systems to the rapidly changing needs of the industries we serve.



Drives Manufacturing

Parker drive products are manufactured globally to provide our customers with quality products at a competitive price point. In addition to factory-direct support, Parker provides sales assistance and local technical support through a group of dedicated sales teams and a network of authorized systems integrators, field service engineers, and technical distributors across the globe. For contact information, please refer to the Sales Offices listed on the back cover of this document or visit www.parker.com/emdusa



Rohnert Park, CA



Offenburg, Germany



Wuxi, China



Chennai, India

Variable Speed Drive - AC30 Series

Overview

Description

AC30 drive has been designed to provide users with exceptional levels of control, from simple open-loop pumps and fans through to closed-loop process line applications. Its flexible and highly modular construction enables a wide range of communications and I/O modules to be easily added as required.

The AC30 has been designed with simplicity in mind, but this doesn't compromise its functionality. Integrated macros for a range of applications and PLC functionality enable more capable users to create sophisticated control that would previously have required a separate PLC.

Designed for operation in environment class 3C3 and 3C4 for Hydrogen Sulphide (H₂S) as standard (tested at 25 ppm for 1200 hours), temperatures up to 50° C with optional integrated EMC filter to C2 1st environment and DC link choke to reduce line harmonics. AC30 also complies with RoHS substance restrictions in accordance with EC Directive 2011/65/EU. Units through 100 HP are marine certified by DNV-GL.



Features

Flexibility

- Open-loop or optional closed-loop operation with pulse encoder or resolver feedback module
- Suitable for operation with AC induction and Permanent Magnet AC (PMA) servo motors
- Ethernet TCP/IP as standard
- Supports both IEC61131-3 CODESYS programming via PDD & PDQ; or DSE / DSElite depending upon firmware installed
- I/O expansion options (Dependent upon firmware installed. See chart on page 9)
- Support for popular industrial fieldbuses
- Chassis or through-panel mount as standard

Simplicity

- Parker DSElite or Parker Drive Quicktool (PDQ) drive management software tool
- Multi-language graphical keypad
- Quick start wizards
- Terminal covers removable with drive in place

Designed with you in mind

Throughout every stage of the design process, our engineering teams worked to equip the AC30 with a wealth of features that benefit both OEMs and End-users alike.

Working with the three principles of Flexibility, Simplicity and Reliability in mind, our engineers have created a product that not only delivers class-leading performance but also offers excellent usability in a host of motor control applications.

Flexibility

A fully featured list of standard functionality along with the use of common control and option modules allows users to put the drive to work in many different open or closed-loop applications without having to invest significant time and effort in re-engineering motor control systems.

Simplicity

From the clear and concise backlit LCD display to the power terminal covers that can be removed with the drive in the cabinet, AC30 has been engineered to make the process of operating and maintaining the drive as easy as possible.

Reliability

Although no one can guarantee problems will never happen, our engineers have taken every possible step to reduce their likelihood of occurring. We have included a number of features in the AC30 that will ensure any loss of productivity is minimized and production restarted as safely and as soon as possible.



Engineered cooling improves reliability

- Intelligent design minimizes force ventilation requirements
- Removable fan improves maintainability
- Isolated power stack cooling path reduces contamination of control electronics

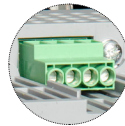

Unobstructed access to power and dynamic brake terminals

- Terminal covers removable with drive in place
- Dynamic brake switch included as standard
- Easy access to DC Bus connections

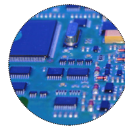

Suitable for harsh environments

- AC30 is conformally coated as standard and meets the requirements of environment classes 3C1, 3C2 (all defined substances) plus 3C3 and 3C4 for Hydrogen Sulphide (H₂S)
- Internal EMC filter options up to C2 1st environment for use in commercial buildings
- CE marked to EN61800-5-1 and NRTL listed to UL508C and C22.2#14
- DC chokes above 3 HP reduce harmonics to below IEC/EN61000-3-12 limits
- Marine certified by GNV-DL through 100 HP



Compact footprint, chassis or through-panel mounting

- Multi-position feet with keyhole slots for ease of mounting
- Reduced heat radiation allows side-by-side mounting



Expandable I/O capabilities

- A range of option modules expand AC30 to accommodate application specific I/O
- High-performance, closed-loop control with pulse encoder or resolver feedback module
- Spring clamp terminals reduce installation time and risk of loose connections



Ethernet connectivity and built in diagnostic web pages

- Built in web pages allow AC30 to be interrogated over the onboard Ethernet and Modbus TCP/IP connection
- **LINKnet** compatible when using DSE/DSELite firmware



Simplified configuration and data storage with SD cards

- SD card simplifies firmware updates and allows drive configuration and data to be stored



Intuitive and easy to use, multi-function graphical keypad

- Remote mountable and easy to use tactile keypad makes drive setup and operation simple



Safe-Torque-Off (STO) for safety critical applications

- Protecting users and machinery against unexpected motor start-up in accordance with EN13849-1 at PLe Cat3 or SIL 3 to EN61800-5-2

Field-installable communications

- Seamless integration into automation systems

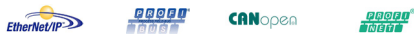

Communications modules compatible only when using IEC61131-3 CODESYS firmware



Graphical Keypad

The tactile IP55 keypad can be mounted either on the drive itself or remotely and provides access to all drive functions.

The backlit LCD display can be configured to present information in any one of a number of different languages, or even in your own custom language with your own user-defined units.

Simple Setup Wizard and Macros

- Integrated quick start wizards means you don't have to be an expert to configure the drive within minutes
- Dedicated macros and integrated function blocks simplify the creation of specific motor control applications

Keypad Remote Mounting

The graphical keypad can be mounted remotely to the drive with the use of a connecting cable. When remote mounting, a blanking cover can be fitted to the drive in place of the keypad.

AC30 Series Variable Speed Drive

Overview

The AC30 is a modular product allowing users to select power stack, control module, I/O and communications modules and accessories to perfectly match the requirements of the application, making it a highly customizable yet cost effective solution. The three interchangeable control modules provide the basis for the series: the standard AC30V control module, the AC30P module with a host of advanced connectivity options, and the AC30D module which adds dual encoder and registration mark system capability.

1) Select Power Stack



Power stacks range from 1 to 650 HP.

2) Select Control Module



A range of control modules (V, P, or D) offer varying levels of intelligent automation control.

3) Select Comms & I/O Options



A wide range of communications, fieldbus, I/O and feedback options are available.

4) Choose accessories



Additional product accessories can be ordered to suit application and installation requirements.

AC30 Series Capability & Connectivity



AC30V

The AC30V is the base drive for **standalone applications**. More than a basic pump and fan drive, its program can be easily modified to suit the application using DSE / DSELite when using DSE firmware or PDD / PDQ when using IEC61131-3 CODESYS firmware.



AC30P

Supporting latest developments in IoT and employing principles discussed in Industry 4.0 the AC30P is equipped with **dual Ethernet ports**. This allows more advanced applications including multiple drive configurations. Plug into one port and access multiple drives supported by 1588 time synchronized peer to peer communication.



AC30D

The AC30D module gives you the great features of the AC30P as well as additional built in terminals to allow **dual encoder inputs and an encoder output**. This gives systems functionality to the AC30 allowing “electronic line shaft” capability, phase locking between drives, and registration control. This also frees up the I/O plug in slot to allow for even more I/O to be added if needed.

Feature	Using IEC61131-3 CODESYS Firmware			Using DSE Firmware		
	AC30V	AC30P	AC30D	AC30V	AC30P	AC30D
Application Macros	Basic	System	System	Basic	System	System
Safety Torque Off (STO)	✓	✓	✓	✓	✓	✓
Modbus Server	✓	✓	✓	✓	✓	✓
Basic web server	✓	✓	✓			
Parker Drive Quick (PDQ) tool programming	✓	✓	✓			
DSE/DSELite system programming				✓	✓	✓
DSE function block libraries				✓	✓	✓
IEC61131-3 System Application libraries		✓	✓			
Ethernet/IP	Option	✓	✓	✓	✓	✓
Profinet	Option	✓	✓			
Profibus	Option	Option	Option			
CANopen	Option	Option	Option			
EtherCAT	Option	Option	Option			
RS485/Modbus RTU	Option	Option	Option			
Modbus client		✓	✓		✓	✓
IEEE1588 time synchronized peer to peer comms		✓	✓		✓	✓
LINKnet time synchronized peer to peer comms				✓	✓	✓
SMART diagnostics		✓	✓		✓	✓
User customizable web server		✓	✓		✓	✓
Parker Drive Developer (PDD) advanced programming		✓	✓			
Virtual master synchronization (same as AC890)		✓	✓		✓	✓
Multi-axis phase lock (same as AC690+ system board/890)		✓	✓		✓	✓
Resolver feedback	Option	Option	Option	Option	Option	Option
Dual encoder inputs			✓			✓
Programmable encoder output			✓			✓

System Connectivity

The AC30 Series can be configured to operate in a number of different power control configuration modes to suit the exact requirements of your application. The flexibility of the AC30 Series enables our range of control modules to operate standalone or as an integral part of any automation architecture.

System Integration

The AC30 series can be easily integrated into your application supported by the wide range of connectivity options. AC30 series control modules can be programmed with our suite of software tools allowing users to configure the product to exactly match the application. Connectivity is provided via our hardware IO terminals offered on all control modules and expanded with our IO options or via standard and optional fieldbus modules.¹

¹Option modules supported only when using IEC61131-3 CODESYS firmware

Hardwired I/O Configuration

The AC30 series offers analog and digital inputs and outputs to maximize application compatibility. The I/O can be expanded using 7004 option modules.

Our standard application macros set each I/O point to a dedicated function. For customization the I/O can be configured to match your application using PDD or PDQ.



Fieldbus Connectivity

All AC30 variants include Ethernet. Using IEC61131-3 CODESYS firmware, ModbusTCP/IP and ProfiNet are standard with Ethernet /IP and a range of common field bus protocols supported via option modules.

Using DSE firmware, Modbus TCP/IP, Ethernet/IP and LINKNet are standard. Field bus option cards are not supported.



Peer to Peer Configuration

The standard Ethernet on the AC30P/D offers peer to peer communication between drives. This allows for seamless data transfer. The peer to peer communication is 1588 time synchronized allowing phase locking between axis independent of which firmware is loaded.²



²When using DSE firmware both IEEE1588 and LINKnet are supported simultaneously

Technical Specifications

Ratings

Order Code	Normal Duty Ratings			Heavy Duty Ratings			Frame
	kW / HP	Output Current A		kW/HP	Output Current A		
		400 VAC	480 VAC		400 VAC	480 VAC	

380-480 (± 10 %) VAC Supplies Three Phase

31x-4D0004-B*-2S-0000	1.1 / 1.5	3.5	3	0.75/1	2.5	2.1	D
31x-4D0006-B*-2S-0000	2.2 / 3	5.5	4.8	1.5/2	4.5	3.4	D
31x-4D0010-B*-2S-0000	4/5	10	7.6	3/4	7.5	5.8	D
31x-4D0012-B*-2S-0000	5.5 / 7.5	12	11	4/5	10	7.6	D
31x-4E0016-B*-2S-0000	7.5 / 10	16	14	5.5/7.5	12	11	E
31x-4E0023-B*-2S-0000	11/15	23	21	7.5/10	16	14	E
31x-4F0032-B*-2S-0000	15 / 20	32	27	11/15	23	21	F
31x-4F0038-B*-2S-0000	18 / 25	38	36	15/20	32	27	F
31x-4G0045-B*-2S-0000	22 / 30	45	40	18/25	38	36	G
31x-4G0060-B*-2S-0000	30 / 40	60	52	22/30	45	40	G
31x-4G0073-B*-2S-0000	37 / 50	73	65	30/40	60	52	G
31x-4H0087-B*-2S-0000	45 / 60	87	77	37/50	73	65	H
31x-4H0105-B*-2S-0000	55 / 75	105	96	45/60	87	77	H
31x-4H0145-B*-2S-0000	75 / 100	145	124	55/75	105	96	H
31x-4J0180-B*-2S-0000	90 / 125	180	156	75/100	145	124	J
31x-4J0205-B*-2S-0000	110 / 150	205	180	90/125	180	156	J
31x-4J0260-B*-2S-0000	132 / 200	260	240	110/150	205	180	J
31x-4K0315-BE-2S-0000	160 / 250	315	302	132/200	260	240	K
31x-4K0380-BE-2S-0000	200 / 300	380	361	160/250	315	302	K
31x-4K0440-BE-2S-0000	250 / 350	440	414	200/300	380	361	K
31x-4L0530-NE-2S-0000	315 / 450	530	520	280/400	440	480	L
31x-4L0590-NE-2S-0000	355 / 500	590	590	315/450	530	520	L
31x-4M0650-NE-2S-0000	400 / 550	650	650	355/500	590	590	M
31x-4M0700-NE-2S-0000	450 / 600	700	680	400/550	650	640	M
31x-4N0790-NE-2S-0000	485 / 650	790	770	450/600	700	700	N

x = Control module type: V, P, or D

* N = No C3 Filter (normally stocked) E = with C3 filter (special order)

Frames L, M & N only available with C3 filter and do not have a brake module

Electrical Characteristics

Power Supply	480 V Nominal
Rated Input Voltage	3 Ø 380-480 VAC ±10%
Input Frequency	45-65 Hz
Maximum Switching Frequency	4 kHz up to maximum of 12 kHz - de-rating may apply
Overload: Heavy Duty	150% for 60 seconds - 180% for 3 seconds
Overload: Normal Duty	110% for 60 seconds - 180% of HD full load current for 3 seconds
Output Frequencies	0-500 Hz at 4 kHz switching frequency
	0-590 Hz at 8 kHz switching frequency
	0-590 Hz at 12 kHz switching frequency
Earth Leakage Current	>10 mA (all models)

Technical Specifications

Environmental Characteristics

Operating Temperature	0 to +40°C (32°F to 104°F) Normal Duty, 0 to +45°C (32°F to 113°F) Heavy Duty, derate up to a maximum of +50°C (122°F) (Refer to manual for derating specifics)
Storage Temperature	-25°C to +55°C (-13°F to 131°F)
Shipping Temperature	-25°C to +70°C (-13°F to 158°F)
Product Enclosure Rating (Panel mounted) (Through-panel mounted)	IP20 - remainder of surfaces (Europe) UL (c-UL) Open Type (North America) IP20 UL (c-UL) Open Type (North America) IP20 UL (c-UL) Open Type (North America)
Altitude	1000 m ASL. Derate output by 1% per 100 m to a maximum of 2000 m
Operating Humidity	Maximum 85% relative humidity at 40°C (104°F) non-condensing
Atmosphere	Non-flammable, non-corrosive and dust free
Climatic Conditions	Class 3k3, as defined by EN60721-3-3
Chemically Active Substances	For the standard product, compliance with EN60271-3-3 is: <ul style="list-style-type: none"> • Both classes 3C3 and 3C4 for Hydrogen Sulphide gas (H₂S) at a concentration of 25 ppm for 1200 hours • Both classes 3C1 (rural) and 3C2 (urban) for all 9 defined substances as defined in table 4
Operating Vibration	Test Fc of EN60068-2-6 10 Hz<=f<=57 Hz sinusoidal 0.075 mm amplitude 57 Hz<=f<=150 Hz sinusoidal 1 g 10 sweep cycles per axis on each of three mutually perpendicular axes
Overvoltage Category	Overvoltage category III (numeral defining an impulse withstand level)
Pollution Degree	Pollution degree II (non-conductive pollution, except for temporary condensation) for control electronics Pollution Degree III (dirty air rating) for through-panel mounted parts

Standards and Conformance

North America/Canada	Complies with the requirements of UL508C and CSA22.2 #14 as an open-type drive
Europe	This product conforms with the Low Voltage Directive 2006/95/EC
EMC Compatibility	CE Marked in accordance with 2004/108/EC (EMC Directive)
RoHS Compliance	This product complies with RoHS substance restrictions in accordance with EC Directive 2011/65/EU
Reach	This product complies with the REACH regulations EC1907/2006
European Machinery Directive	Safe-Torque-Off (STO) complies with the requirements of ISO13849-1 (Safety-related parts of control systems) at PLe Cat3 or SIL 3 to EN61800-5-2
DNV Marine Certification (Det Norske Veritas)	Complies with the 'Classification of Ships, High Speed & Light Craft and Det Norske Veritas Offshore Standards'. This applies to all AC30 Frequency converters with powers up to 100 HP for use in marine and offshore applications

Dimensions

Panel Mounting

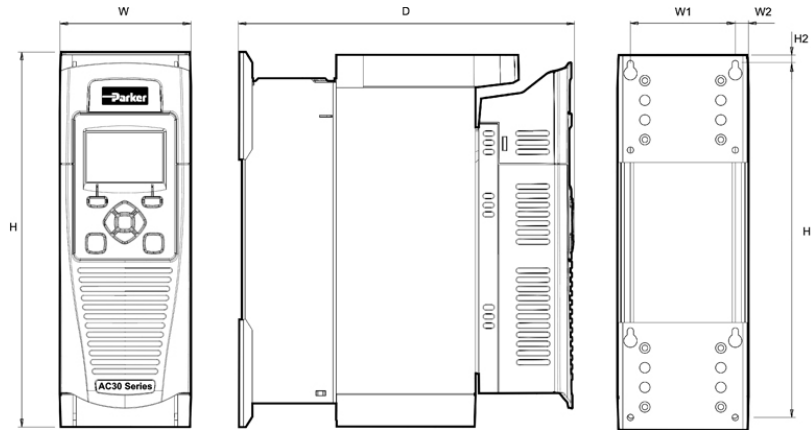

Approximate Dimensions [in/mm]

Size	Weight [lb/kg]	H	H1	H2	W	W1	W2	D	Mounting
Frame D	10/4.5	11.26/286.0	10.6/270.0	0.25/6.5	3.93/100.0	3.15/80.0	0.39/10.0	10.0/255.0	4.5mm slot, M4 mountings
Frame E	15/6.8	13.11/333.0	12.6/320.0	0.25/6.5	4.92/125.0	3.93/100.0	0.49/12.5	10.0/255.0	
Frame F	22/10.0	15.07/383.0	14.5/370.0	0.25/6.5	5.90/150.0	4.92/125.0	0.49/12.5	10.0/255.0	
Frame G	49/22.3	18.90/480.0	18.31/465.0	0.29/7.25	8.66/220.0	7.48/190	0.51/13.0	11.30/287	5.5mm slot, M5
Frame H	95/42.8	26.38/670.0	25.59/650.0	0.39/10.0	10.24/260.0	8.66/220	0.79/20	12.44/316	6.8mm slot, M6
Frame J	196/89	31.5/800	30.7/780	0.39/10.0	13/330	11.22/285	0.89/22.5	14.72/374	M8 mountings
Frame K	276/125	51.2/1300	50/1272	0.55/14.0	15.75/400	11/280	2.36/60	15.16/385	M10 mountings
Frame L	401/182	52.76/1340	51.57/1310	0.59/15	21.06/535	18.5/470	1.26/32	14.88/378	
Frame M	529/240	57.6/1463	57.01/1448	0.59/15	23.78/604	21.46/545	1.16/29.5	14.88/378	
Frame N	586/266	62.72/1593	61.54/1563	0.59/15	23.78/604	21.46/545	1.16/29.5	14.88/378	

*The AC30D control module increases the shown depth by 18mm on all frame sizes.

Through-Panel Mounting

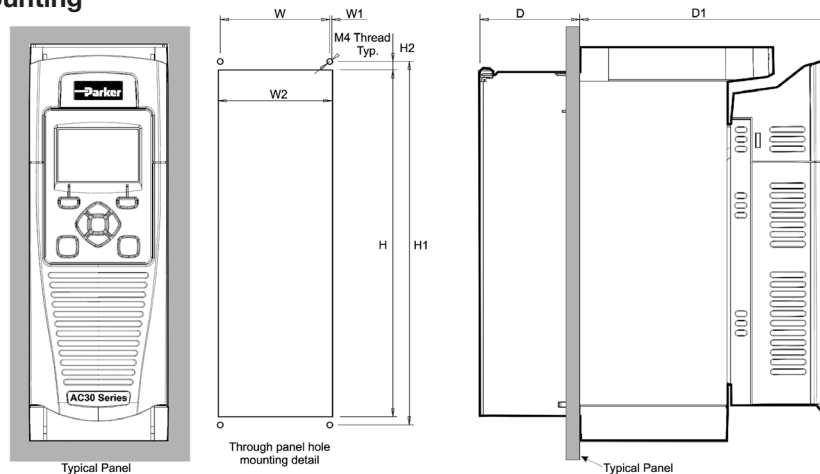

Approximate Dimensions [in/mm]

Size	H	H1	H2	W	W1	W2	D	D1	Mounting
Frame D	9.8/250	10.3/262	0.24/6	3.1/79	0.06/1.5	3.2/82	2.8/72	7.1/181	Use M4 mountings
Frame E	11.7/297	12.2/309	0.24/6	4.1/104	0.04/1	4.0/102	2.8/72	7.1/181	
Frame F	13.7/347	14.1/359	0.24/6	5.1/129	0.04/1	5.0/127	2.8/72	7.1/181	
Frame G	17.3/440	17.9/455.8	0.31/7.9	7.7/195	0.02/0.4	7.7/195.8	3.74/95	7.5/190	Use M5 mountings
Frame H	24.3/617	25.2/641	0.47/12	8.6/218	4.5	8.9/227	3.9/99	8.3/211	Use M6 mountings
Frame J	29.3/745	765	0.39/10	10.8/275	12.5	11.8/300	5.0/128	9.55/242.6	Use M6 mountings

Through panel mounting is not offered for frame K to N.

Connections

Power connections

Term.	Description
DB+	Dynamic Brake Resistor
DB-	Dynamic Brake Resistor
DC+	DC Link Bus +
DC-	DC Link Bus -
L1	L1 AC Input Supply
L2	L2 AC Input Supply
L3	L3 AC input Supply
M1	Motor Output 1/U
M2	Motor Output 2/V
M3	Motor Output 3/W

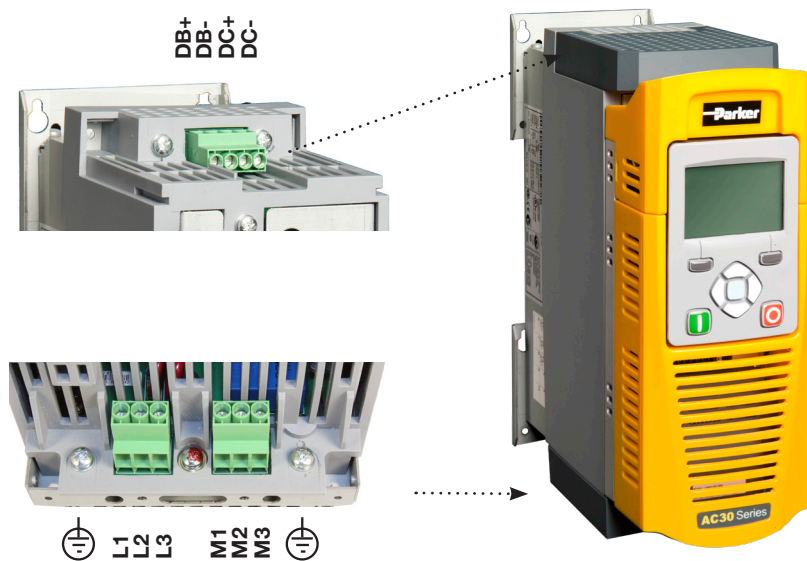

Safe Torque Off (STO)

The AC30 series features Safe Torque Off functionality as standard, offering users protection against unexpected motor start-up in accordance with EN13849-1 at PLe Cat 3 or SIL 3 to EN61800-5-2.

The STO functionality helps protect personnel and machinery by preventing the drive from restarting automatically. It disables the drive pulses and inhibits the power supply to the motor, so that the drive cannot generate any potentially hazardous movement. The state is monitored internally within the drive.

The example wiring diagram shows the minimum connections required to implement STO with the AC30 series AC drives.

Term.	Label	Description
X10/01	STO A Input	STO Channel A input signal
X10/02	STO Common	Return signals for STO A and STO B
X10/03	STO B Input	STO Channel B input signal
X10/04	STO Common	Return signals for STO A and STO B
X10/05	STATUS A	STO Status Indication
X10/06	STATUS B	STO Status Indication

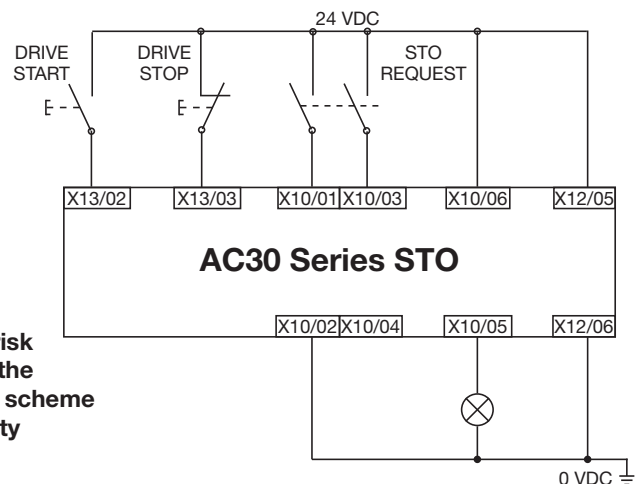

Users must conduct a risk assessment to identify the appropriate STO wiring scheme and ensure that all safety requirements are met.



It is the user's responsibility to ensure the safe and correct use of the STO function of the AC30 Series. User's should read and fully understand chapter 6 (Safe Torque Off) of the product user manual. Manual No. HA501718U001

Control wiring connections: AC30V & AC30P

Term.	Label
X10/01	STO A Input
X10/02	STO Common Return
X10/03	STO B Input
X10/04	STO Common Return
X10/05	STO Status A
X10/06	STO Status B
X11/01	ANIN 01 Analog Input (± 10 V, 0-10 V, 0-20 mA, 4-20 mA)
X11/02	ANIN 02 Analog Input (± 10 V, 0-10 V)
X11/03	ANOUT 01 Analog output (± 10 V, 0-10 V)
X11/04	ANOUT 02 Analog output (0-10 V, 0-20 mA, 4-20 mA)
X11/05	+10 V Reference
X11/06	-10 V Reference
X12/01	DIGIN04 / DIGOUT 01 Digital In/Out
X12/02	DIGIN05 / DIGOUT 02 Digital In/Out
X12/03	DIGIN06 / DIGOUT 03 Digital In/Out
X12/04	DIGIN07 / DIGOUT 04 Digital In/Out
X12/05	User +24 V Output
X12/06	0 V Common

Term.	Label
X13/01	0V Common
X13/02	DIGIN 1 Digital Input
X13/03	DIGIN 2 Digital Input
X13/04	DIGIN 3 Digital Input
X13/05	+24 V Auxiliary Input
X13/06	0 V Auxiliary Input
X14/01	Relay Output 01 (Contact A)
X14/02	Relay Output 01 (Contact B)
X14/03	Relay Output 02 (Contact A)
X14/04	Relay Output 02 (Contact B)

*Relay outputs are not present on AC30P/D. These are replaced by dual Ethernet ports.

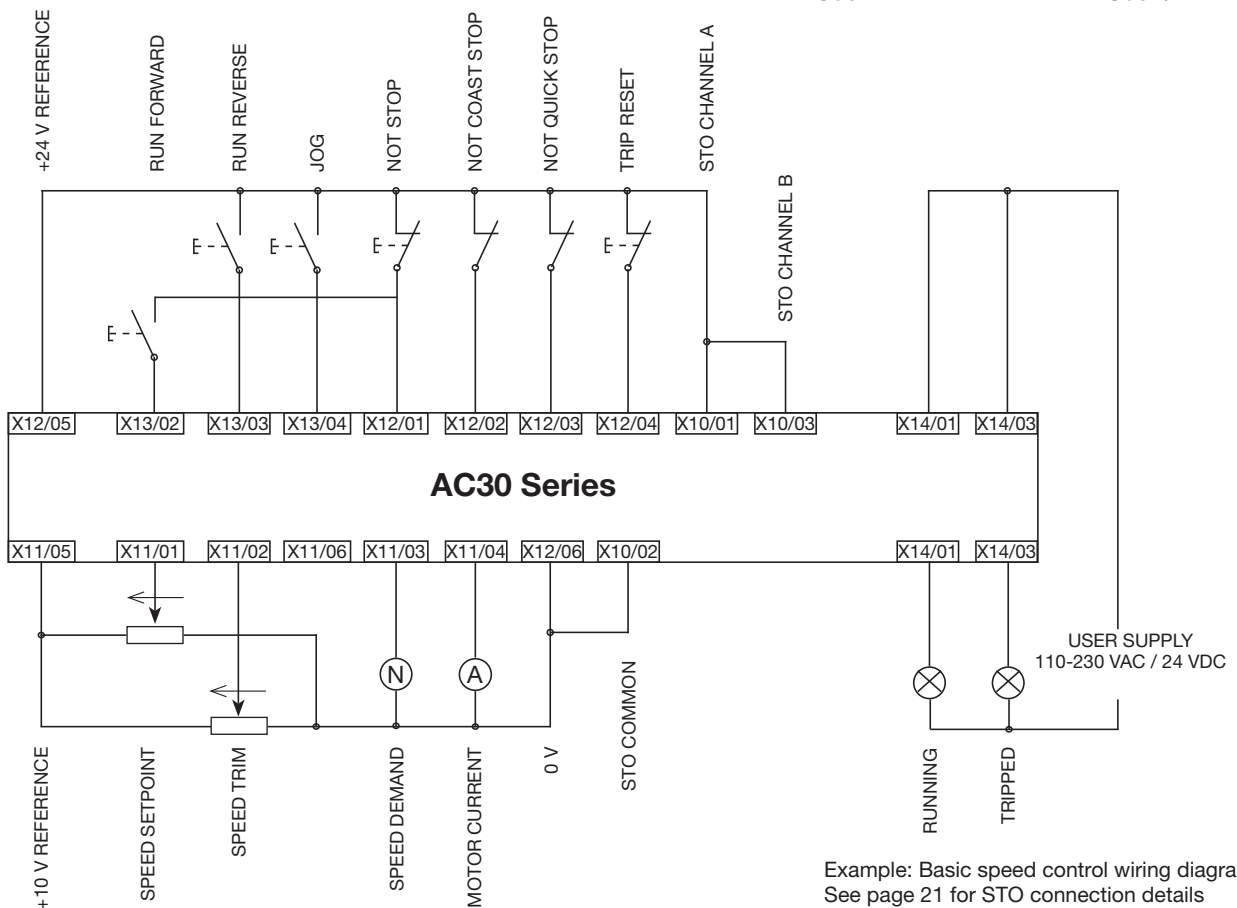
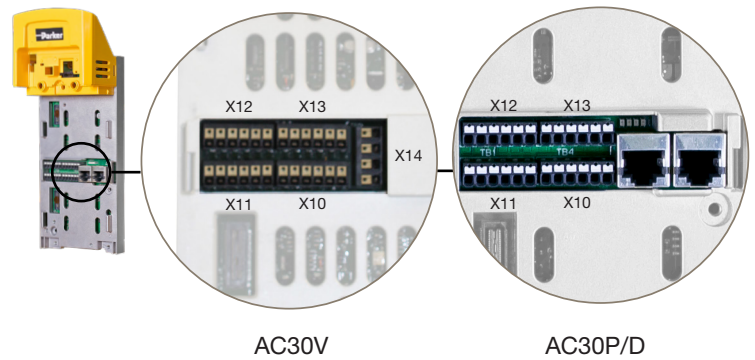

Example: Basic speed control wiring diagram
See page 21 for STO connection details

Control wiring connections: AC30D

The wiring on the AC30D is the same as AC30P with the additional systems connections shown below.

Term.	Label
X30/01	DIGIN 1
X30/02	DIGIN 2
X30/03	DIGIN 3
X30/04	DIGIN 0V
X30/05	+24V System Aux. Input
X30/06	0V System Aux. Input
X31/01	Encoder 2 - A Input
X31/02	Encoder 2 - /A Input
X31/03	Encoder 2 - B Input
X31/04	Encoder 2 - /B Input
X31/05	Encoder 2 - Z Input
X31/06	Encoder 2 - /Z Input
X31/07	Encoder PSU Output - Positive Terminal (internally connected to X32/07)
X31/08	Encoder PSU Output - 0V Terminal (internally connected to X32/08)

Term.	Label
X32/01	Encoder 1 - A Input
X32/02	Encoder 1 - /A Input
X32/03	Encoder 1 - B Input
X32/04	Encoder 1 - /B Input
X32/05	Encoder 1 - Z Input
X32/06	Encoder 1 - /Z Input
X32/07	Encoder PSU Output - Positive Terminal (internally connected to X31/07)
X32/08	Encoder PSU Output - 0V Terminal (internally connected to X31/08)
X33/01	Encoder Transmit - A Output
X33/02	Encoder Transmit - /A Output
X33/03	Encoder Transmit - B Output
X33/04	Encoder Transmit - /B Output
X33/05	Encoder Transmit - Z Output
X33/06	Encoder Transmit - /Z Output

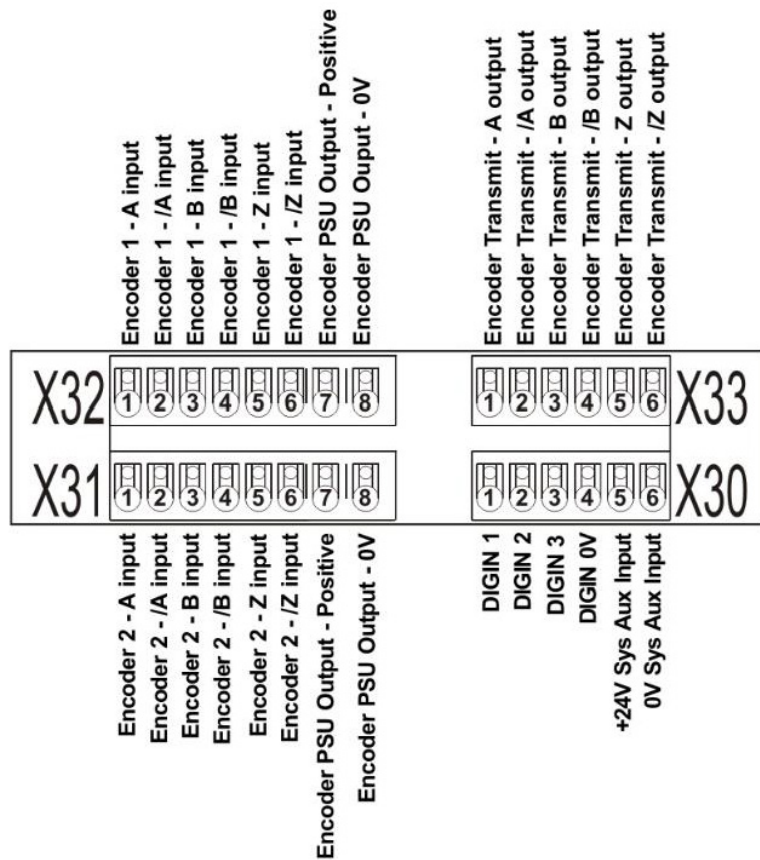
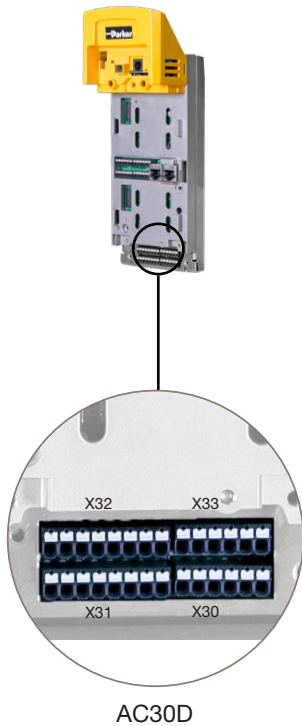

Accessories and Options

Operator Keypad

Order Code	Description
7001-00-00	IP54 Graphical keypad
7001-01-00	Keypad blanking cover
LA501991U300	Keypad remote mounting kit (3 m cable and screws)

Description:

The backlit LCD graphical keypad can be either mounted locally on the drive or remotely with the use of a remote mounting kit. The keypad has 3 pass code protected user access levels. The keypad can be used to set-up and commission the drive, change parameter settings, monitor running status or diagnose warning or alarm conditions. The display information can be shown in English, German, French, Spanish or Italian.



7001-00-00



7001-01-00

Line Reactors, EMC Filters, and C2 Filter Kits

A full range of line reactors, EMC filters and C2 filter kits are available for the AC30



Braking Resistors

These resistor sets are designed for stopping the system at rated power. They are rated for 10 seconds in a 100 second duty cycle. They should be mounted on a heatsink (back panel) in a protected area and covered to prevent injury from burning.



Communication Interfaces

These options apply only to units with IEC61131-3 CODESYS firmware

7003-PB-00	PROFIBUS DP-V1 communication interface
Supported Protocols	PROFIBUS-DP; Demand data and Data exchange
Communication Speed	Up to 12 Mbits/s; automatically detected
Max. number of devices	32 per segment, 126 total
Supported Messages	Up to 152 bytes cyclic I/O, 68 bytes class 1 and 2 acyclic data, 152 bytes configuration data. GSD file provided



7003-EC-00	EtherCAT communication interface
Supported Protocols	CANopen over EtherCAT (CoE) DS301 compliant
Communication Speed	100 Mbits/s
Max. number of devices	65534
Supported Messages	SDO, PDO, NMT, SYNC



7003-CB-00	CANopen communication interface
Profile	DS301 V4.02
Communication Speed	10 k, 20 k, 50 k, 125 k, 250 k, 500 k, 1 Mbits/s or automatically detected
Max. number of devices	127
Supported Messages	SDO, PDO, NMT, SYNC



7003-PN-00	PROFINET I/O communication interface
Supported Protocols	PROFINET I/O Real-Time (RT) Protocol
Communication Speed	100 Mbits/s full duplex
Max. number of devices	Virtually unlimited
Supported Messages	Up to 256 bytes of cyclic I/O in data in each direction

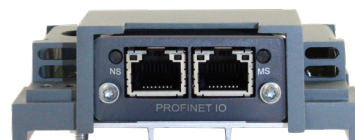

7003-IP-00	Ethernet/IP communication interface
Supported Protocols	Ethernet/IP
Communication Speed	10/100 Mbits/s full/half duplex
Max. number of devices	Virtually unlimited
Supported Messages	Up to 256 bytes of consumed data and 256 bytes of produced data, CIP parameter object support, Explicit messaging

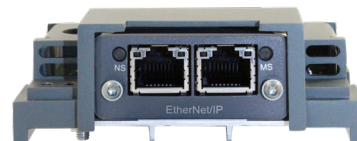

7003-RS-00	RS485 / Modbus RTU communication interface
Supported Protocols	Modbus RTU
Communication Speed	1200 to 115200 bits/s
Max. number of devices	247
Supported Messages	Up to 256 bytes of cyclic I/O data in each direction



Input and Output Cards

7004-01-00 - General Purpose I/O Module

Digital Inputs & Outputs	4x Digital inputs or outputs
Analog Inputs/Outputs	3x Analog inputs (± 10 V)
Relay Outputs	2x Volt-free relay outputs (230 VAC)
Motor Temperature Sensing	1 motor thermistor input
Real time Clock	Included



Description:

The general purpose I/O (GPIO) option module can be fitted to all AC30 series drives in the upper I/O option module slot. The modules are field installable and offer users the opportunity to expand the drive's standard I/O capability, allowing more complex motor control solutions to be implemented.

Connection Details:

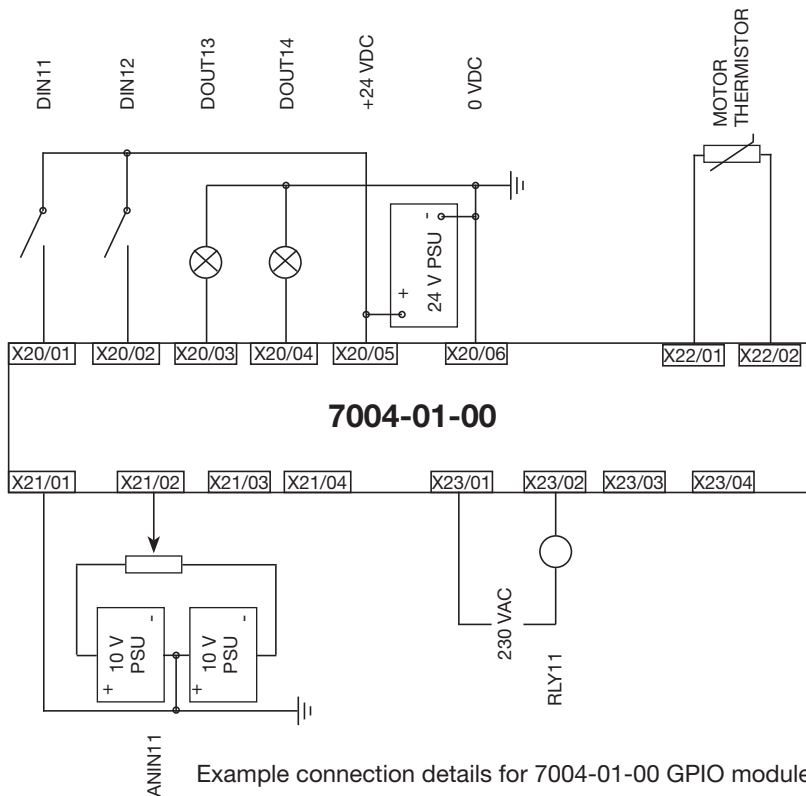

Terminal	Label
X20/01	DIN11/DOU11
X20/02	DIN12/DOU12
X20/03	DIN13/DOU13
X20/04	DIN14/DOU14
X20/05	+24 VDC
X20/06	0 VDC COMMON
X21/01	REFERENCE
X21/02	ANIN11
X21/03	REFERENCE
X21/04	ANIN12
X22/01	MOTOR THERMISTOR
X22/02	MOTOR THERMISTOR
X23/01	RLY11
X23/02	RLY11
X23/04	RLY12
X23/04	RLY12

Input and Output Cards

7004-04-00 - Pulse Encoder Feedback Module

Maximum Input Frequency	250 Hz per channel
Supply Voltage Output	5 V, 12 V, 15 V, 24 V
Input Format	Quadrature, or Clock (inputs A & /A) and Direction (input B & /B)
Motor Thermistor Details	Same as 7004-02-00

Description:

The pulse encoder feedback module allows an incremental encoder to be connected to the AC30 for enhanced torque control and speed regulation. In addition, the option is equipped with a motor thermistor input. This option can be used with all AC30 series control modules to provide full closed-loop vector induction motor control and also to provide a speed reference into any AC30 control module.

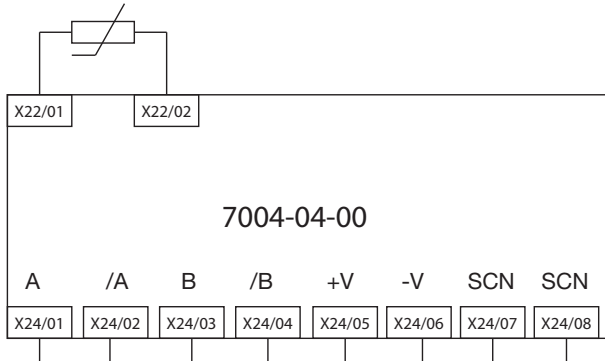

Terminal	Description
X24/01	Channel A
X24/02	Channel /A
X24/03	Channel B
X24/04	Channel /B
X24/05	Supply positive
X24/06	Supply negative
X24/07	Cable screen
X24/08	Cable screen
X22/01	Motor thermistor
X22/02	Motor thermistor

7004-05-00 - Resolver Feedback Module

Description:

The resolver feedback option is compatible with AC30P and AC30D drives featuring firmware versions 2.13 and 3.13 (or later). It offers compatibility with a wide range of resolvers from many different manufacturers. A range of resolver connection cables are available for use with NX, MGV, EY, NV and EX motors from Parker.

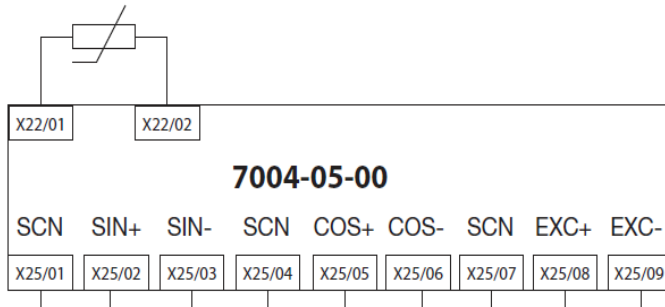

Terminal	Description
X25/01	Cable screen
X25/02	SIN+
X25/03	SIN-
X25/04	Cable screen
X25/05	COS+
X25/06	COS-
X25/07	Cable screen
X25/08	EXC+
X25/09	EXC-
X22/01	Motor thermistor
X22/02	Motor thermistor

AC30 Series Product Configuration

The AC30 is a modular product, allowing users to select the correct power stack, control module and options to perfectly match their application. Simply select the required parts to build a product bill of materials that meets your requirements. Minimum required parts to build a complete drive is one control module and one power stack.

Control Modules



AC30V Control Module



AC30P Control Module



AC30D Control Module

30V Codes	30P Codes	30D Codes	Description
30V-2S-0000	30P-2S-0000	30D-2S-0000	Control module with graphical keypad and standard coating
30V-1S-0000	30P-1S-0000	30D-1S-0000	Control module with blanking cover and standard coating
30V-0S-0000	30P-0S-0000	30D-0S-0000	Control module with standard coating and no graphical keypad



Accessories

Graphical Keypad

Order Code	Description
7001-00-00	Graphical keypad for local or remote mounting
7001-01-00	Keypad blanking cover
LA501991U300	Keypad remote mounting kit (3 m cable and screws)



I/O Options

Order Code	Description
7004-01-00	General purpose I/O module
7004-04-00	Pulse encoder feedback card
7004-05-00	Resolver feedback card

Communication Interfaces



Order Code	Description
7003-PB-00	Profibus DPV1
7003-PN-00	Profinet IO
7003-CB-00	CANopen
7003-IP-00	Ethernet/IP
7003-EC-00	EtherCAT
7003-RS-00	RS485/Modbus RTU

AC30 Complete Drive Product Order Code

The AC30 series may be configured to order under a single product number. This product code includes one power stack and one control module. Option modules must still be ordered separately. Please see table on page 9 for complete list of features offered by each of the AC30 variations.

	1	2	3	4	5	6	7	8	
Order example	31V	4	D	0004	B	E	2	S	0000

1 Device Family

31V	AC30V - basic standalone unit for single axis applications
31P	AC30P - Includes peer-to-peer and advanced comms
31D	AC30D - Includes dual encoder ports and encoder output

2 Voltage

4	400 V nominal (400 - 460)
----------	---------------------------

3 Frame Size and Current Rating

	HP (normal/heavy duty)	KW (normal/heavy duty)
D0004	1.1/1.5	0.75/1
D0006	2.2/3	1.5/2
D0010	4/5	3/4
D0012	5.5/7.5	4/5
E0016	7.5/10	5.5/7.5
E0023	11/15	7.5/10
F0032	15/20	11/15
F0038	18/25	15/20
G0045	22/30	18/25
G0060	30/40	22/30
G0073	37/50	30/40
H0087	45/60	37/50
H0105	55/75	45/60
H0145	75/100	55/75
J0180	90/125	75/100
J0205	110/150	90/125
J0260	132/200	110/150
K0315	160/250	132/200
K0380	200/300	160/250
K0440	250/350	200/300
L0530	315/450	280/400
L0590	355/500	315/450
M0650	400/550	355/500
M0700	450/600	400/550
N0790	485/650	450/600

4 Brake Switch ⁽¹⁾

B	Brake switch fitted (Frames D - K. Use "N" for frames L - N)
----------	--

5 EMC Filter ⁽²⁾

N	No filter fitted
E	Category C3 filter fitted (standard)
F	Category C2 filter fitted - consult fact.

6 Graphical Keypad

2	Graphical keypad fitted
----------	-------------------------

7 Environmental Coating ⁽³⁾

S	Standard 3C3 coating
----------	----------------------

8 Special Options

0000	No special options
-------------	--------------------

⁽¹⁾ Drives include brake switch as standard. For non-brake options please contact factory.

⁽²⁾ The choice of filter should be determined by the environment in which the drive will be installed as defined in IEC/EN61800-3: C2 = domestic & commercial, C3 = industrial
C2 filter is only offered on frames D-H. For other frames use external EMC filter.

Typically frames D-K are stocked with no filter (option "N") and frames L-N are stocked with C3 filter (option "E").

⁽³⁾ AC30 is conformally coated as standard for use in environments class 3C3 and 3C4 for Hydrogen Sulphide gas. It is also compliant to both classes 3C1 (rural) and 3C2 (urban) for all nine substances defined in table 4 in EN60271-3-3.

Parker DSELite Software (For DSE Firmware)

Description:

DSELite is a powerful, intuitive, self documenting graphical configuration and diagnostic software tool which supports all AC30 variants that are flashed to DSE firmware. It also supports all current and most legacy Parker industrial drives.

DSELite can be used to configure applications ranging from simple speed and torque controlled applications such as extruders and mixers through very complex system applications such as center winders. It comes with an array of time proven function blocks for center winders, PID control, master section control, and other continuous process applications. These may be user modified to best suit each application.

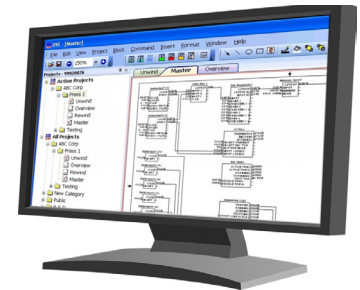

All parameters are available for monitoring in the on-board chart function.

DSE Development provides all the same DSELite functionality and adds the ability to create single project containing multiple drives all connected via the LINKnet peer to peer network. LINKnet simultaneously supports DSE and Ethernet/IP thereby eliminating the need for gateway hardware and associated programming when integrating Parker drives with many popular PLC's.

Parker DSELite can be downloaded free of charge from the Parker website.
www.parker.com/ssdusa/software

Parker Drive Quicktool (PDQ) Software (For IEC61131-3 CODESYS Firmware)

Description:

Parker Drive Quick tool (PDQ) is the easy to use, free of charge software tool that supports AC30 drives flashed to IEC61131-3 CODESYS firmware.

Parker Drive Developer (PDD), allows advanced users to configure AC30 drives for complex applications when the IEC61131-3 CODESYS platform is preferred.

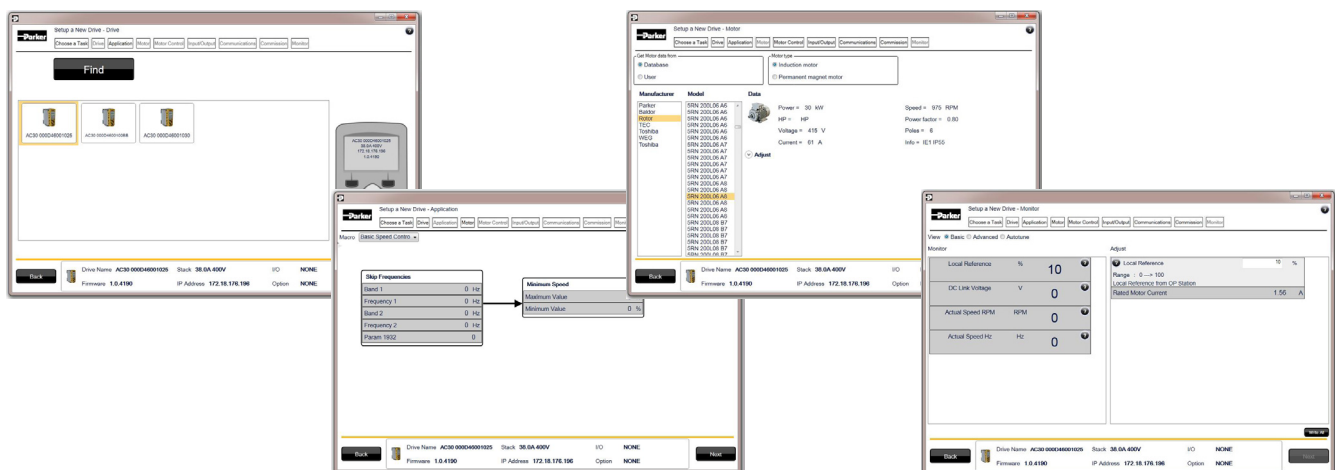

Parker Drive Quicktool is shipped with every drive and can also be downloaded free of charge from the Parker website.
www.parker.com/ssdusa/software

Parker Worldwide

AE – UAE, Dubai

Tel: +971 4 8127100
parker.me@parker.com

AR – Argentina, Buenos Aires

Tel: +54 3327 44 4129

AT – Austria, Wiener Neustadt

Tel: +43 (0)2622 23501-0
parker.austria@parker.com

AT – Eastern Europe,

Wiener Neustadt
Tel: +43 (0)2622 23501 900
parker.easteurope@parker.com

AU – Australia, Castle Hill

Tel: +61 (0)2-9634 7777

AZ – Azerbaijan, Baku

Tel: +994 50 2233 458
parker.azerbaijan@parker.com

BE/LU – Belgium, Nivelles

Tel: +32 (0)67 280 900
parker.belgium@parker.com

BR – Brazil, Cachoeirinha RS

Tel: +55 51 3470 9144

BY – Belarus, Minsk

Tel: +375 17 209 9399
parker.belarus@parker.com

CA – Canada, Milton, Ontario

Tel: +1 905 693 3000

CH – Switzerland, Etoy

Tel: +41 (0)21 821 87 00
parker.switzerland@parker.com

CL – Chile, Santiago

Tel: +56 2 623 1216

CN – China, Shanghai

Tel: +86 21 2899 5000

CZ – Czech Republic, Klecany

Tel: +420 284 083 111
parker.czechrepublic@parker.com

DE – Germany, Kaarst

Tel: +49 (0)2131 4016 0
parker.germany@parker.com

DK – Denmark, Ballerup

Tel: +45 43 56 04 00
parker.denmark@parker.com

ES – Spain, Madrid

Tel: +34 902 330 001
parker.spain@parker.com

FI – Finland, Vantaa

Tel: +358 (0)20 753 2500
parker.finland@parker.com

FR – France, Contamine s/Arve

Tel: +33 (0)4 50 25 80 25
parker.france@parker.com

GR – Greece, Athens

Tel: +30 210 933 6450
parker.greece@parker.com

HK – Hong Kong

Tel: +852 2428 8008

HU – Hungary, Budapest

Tel: +36 1 220 4155
parker.hungary@parker.com

IE – Ireland, Dublin

Tel: +353 (0)1 466 6370
parker.ireland@parker.com

IN – India, Mumbai

Tel: +91 22 6513 7081-85

IT – Italy, Corsico (MI)

Tel: +39 02 45 19 21
parker.italy@parker.com

JP – Japan, Tokyo

Tel: +81 (0)3 6408 3901

KR – South Korea, Seoul

Tel: +82 2 559 0400

KZ – Kazakhstan, Almaty

Tel: +7 7272 505 800
parker.easteurope@parker.com

LV – Latvia, Riga

Tel: +371 6 745 2601
parker.latvia@parker.com

MX – Mexico, Apodaca

Tel: +52 81 8156 6000

MY – Malaysia, Shah Alam

Tel: +60 3 7849 0800

NL – The Netherlands,

Oldenzaal
Tel: +31 (0)541 585 000
parker.nl@parker.com

NO – Norway, Ski

Tel: +47 64 91 10 00
parker.norway@parker.com

NZ – New Zealand, Mt Wellington

Tel: +64 9 574 1744

PL – Poland, Warsaw

Tel: +48 (0)22 573 24 00
parker.poland@parker.com

PT – Portugal, Leca da Palmeira

Tel: +351 22 999 7360
parker.portugal@parker.com

RO – Romania, Bucharest

Tel: +40 21 252 1382
parker.romania@parker.com

RU – Russia, Moscow

Tel: +7 495 645-2156
parker.russia@parker.com

SE – Sweden, Spånga

Tel: +46 (0)8 59 79 50 00
parker.sweden@parker.com

SG – Singapore

Tel: +65 6887 6300

SK – Slovakia, Banská Bystrica

Tel: +421 484 162 252
parker.slovakia@parker.com

SL – Slovenia, Novo Mesto

Tel: +386 7 337 6650
parker.slovenia@parker.com

TH – Thailand, Bangkok

Tel: +662 717 8140

TR – Turkey, Istanbul

Tel: +90 216 4997081
parker.turkey@parker.com

TW – Taiwan, Taipei

Tel: +886 2 2298 8987

UA – Ukraine, Kiev

Tel: +380 44 494 2731
parker.ukraine@parker.com

UK – United Kingdom,

Warwick
Tel: +44 (0)1926 317 878
parker.uk@parker.com

US – USA, Cleveland

Tel: +1 216 896 3000

VE – Venezuela, Caracas

Tel: +58 212 238 5422

ZA – South Africa,

Kempton Park
Tel: +27 (0)11 961 0700
parker.southafrica@parker.com



© 2020 Parker Hannifin Corporation. All rights reserved.

Parker Hannifin Corporation Electromechanical & Drives Div.

1140 Sandy Hill Road
Irwin, PA 15642 USA
phone (800) 358-9070
emn_support@parker.com
www.parker.com/emdusa

AC30 Catalog HA473413
Issue 14 Jan2021

