

# Permanent Hose Fittings

25 Series Fittings

26 Series Fittings

43 Series Fittings

56 Series Fittings

71 Series Fittings

77 Series Fittings

79 Series Fittings

81 Series Fittings

91N Series Fittings

93N Series Fittings

CY Series Fittings

HY Series Fittings

SF Series Fittings

[Link to Master Table of Contents](#)

[Link to Section Table of Contents](#)

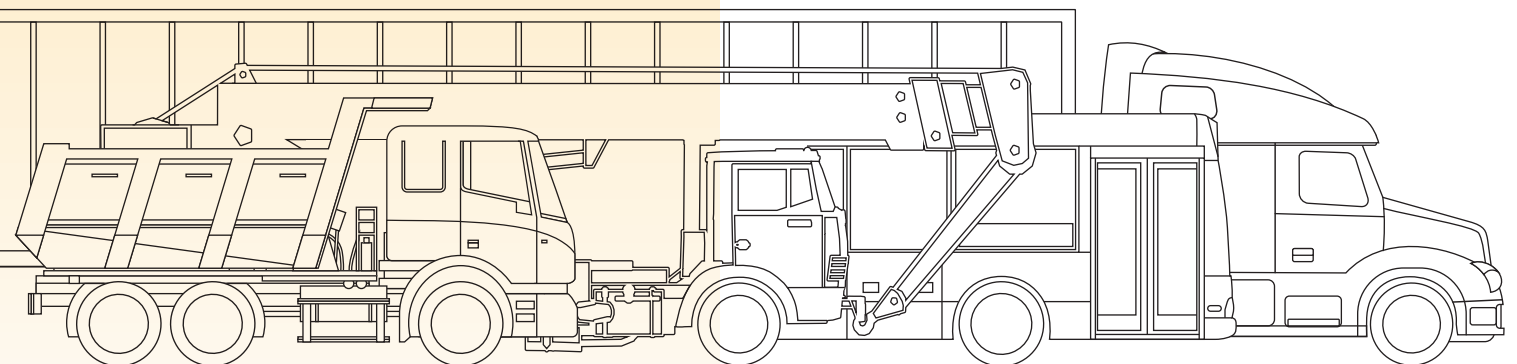

ENGINEERING YOUR SUCCESS.

## Table of Contents



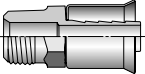
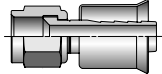
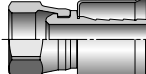

Visual Index .....	E2
25 Series Fittings .....	E14
26 Series Fittings .....	E14
43 Series Fittings .....	E19
56 Series Fittings .....	E32
71 Series Fittings .....	E40
77 Series Fittings .....	E45
79 Series Fittings .....	E52
81 Series Fittings .....	E53
91N/91 Series Fittings .....	E54
93N Series Fittings .....	E57
CY Series Fittings .....	E58
HY Series Fittings .....	E60
SF Series Fittings .....	E65
“How to Order” Information .....	9
Chemical Compatibility Guide.....	O10, <a href="http://www.parker.com">www.parker.com</a>

## Visual Index

### Permanent Hose Fittings – 25 Series

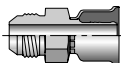
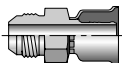
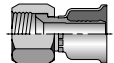
Flange	<b>10125</b> Rigid <a href="#">Page E14</a>	<b>10825</b> Swivel <a href="#">Page E14</a>	<b>17B25</b> Swivel <a href="#">Page I17</a>
			

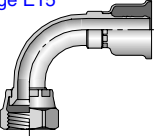
### Permanent Hose Fittings – 26 Series

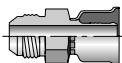
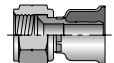
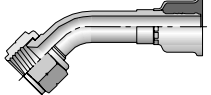
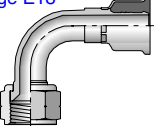
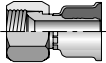
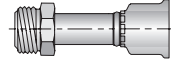
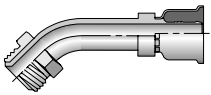
NPTF Pipe	<b>10126</b> Male - Rigid <a href="#">Page E14</a>	JIC 37°	<b>10326</b> Male - Rigid <a href="#">Page E14</a>	<b>10626</b> Female - Swivel <a href="#">Page E14</a>	<b>13726</b> Female - Swivel 45° Elbow - Short <a href="#">Page E15</a>
					
<b>13926</b> Female - Swivel 90° Elbow - Short <a href="#">Page E15</a>	<b>14126</b> Female - Swivel 90° Elbow - Long <a href="#">Page E15</a>	SAE 45°	<b>10426</b> Male - Rigid <a href="#">Page E14</a>	<b>10826</b> Female - Swivel <a href="#">Page E14</a>	<b>17726</b> Female - Swivel 45° Elbow - Short <a href="#">Page E18</a>
					
<b>17926</b> Female - Swivel 90° Elbow <a href="#">Page E18</a>	JIC 37° / SAE 45° Dual Flare	<b>16826</b> Female - Swivel <a href="#">Page E18</a>	Inverted Flare	<b>12826</b> Male - Swivel <a href="#">Page E14</a>	<b>16726</b> Male - Swivel 45° Elbow <a href="#">Page E18</a>
					

**Permanent Hose Fittings – 26 Series (Continued)**

**Inverted Flare (Cont'd)**

**16926**  
Male - Swivel  
90° Elbow  
[Page E18](#)

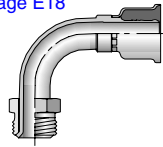

**Seal-Lok™ O-Ring Face Seal**

**1JC26**  
Female - Swivel Short  
[Page E19](#)

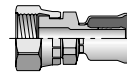

**1J726**  
Female - Swivel  
45° Elbow  
[Page E18](#)

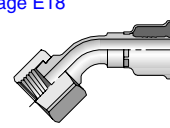

**1J926**  
Female - Swivel 90°  
Elbow - Short  
[Page E18](#)

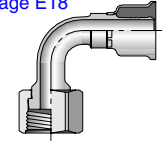

**Tube-O**

**1S526**  
Male - Swivel -  
Short Pilot  
[Page E19](#)

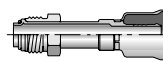

**1S526-PR**  
Male - Swivel -  
Short Pilot  
[Page E19](#)

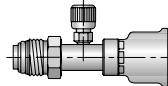

**15R26**  
Male - Swivel  
45° Elbow - Short Pilot  
[Page E17](#)

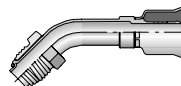

**15K26**  
Male - Swivel  
90° Elbow - Short Pilot  
[Page E16](#)

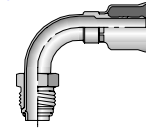

**15K26-PB**  
Male - Swivel  
90° Elbow - Short Pilot  
[Page E16](#)

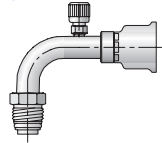

**15K26-PR**  
Male - Swivel  
90° Elbow - Short Pilot  
[Page E16](#)

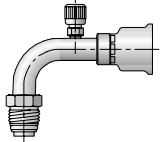

**14526-PR**  
Male - Swivel  
Long Pilot  
[Page E17](#)

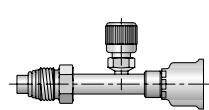

**14526-PT**  
Male - Swivel  
Long Pilot  
[Page E15](#)

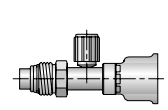

**15M26-PR**  
Male - Swivel  
90° Elbow - Long Pilot  
[Page E16](#)

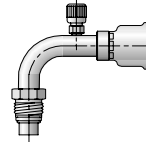

**15M26-PT**  
Male - Swivel  
90° Elbow - Long Pilot  
[Page E17](#)

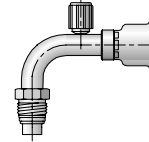

**15G26**  
Male - Rigid  
Internal - Long Pilot  
[Page E15](#)

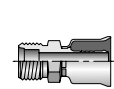

**15G26-PR**  
Male - Rigid  
Internal - Long Pilot  
[Page E15](#)

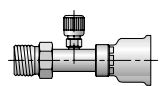

**15S26**  
Female - Swivel  
Short Pilot  
[Page E17](#)

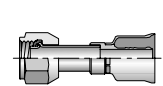

**15H26**  
Female - Swivel 45°  
Elbow - Short Pilot  
[Page E16](#)



**15T26**  
Female - Swivel  
90° Elbow - Short Pilot  
[Page E17](#)

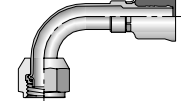

**15926-PB**  
Female - Swivel  
Long Pilot  
[Page E15](#)

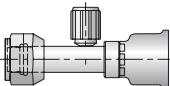

**15926-PT**  
Female - Swivel  
Long Pilot  
[Page E15](#)

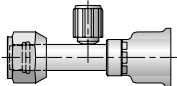

**15N26-PB**  
Female - Swivel  
45° Elbow - Long Pilot  
[Page E17](#)

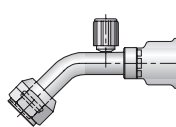

**15N26-PT**  
Female - Swivel  
45° Elbow - Long Pilot  
[Page E17](#)

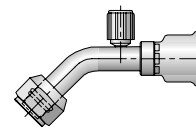

**15L26**  
Female - Swivel  
90° Elbow - Long Pilot  
[Page E16](#)

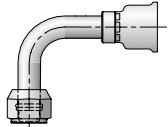

**15L26-PB**  
Female - Swivel  
90° Elbow - Long Pilot  
[Page E16](#)

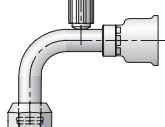

**15L26-PR**  
Female - Swivel  
90° Elbow - Long Pilot  
[Page E16](#)

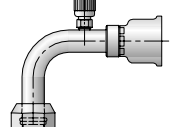

**15L26-PT**  
Female - Swivel  
90° Elbow - Long Pilot  
[Page E16](#)

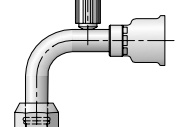

**15P26-PT**  
Male - Swivel  
45° Elbow - Long Pilot  
[Page E17](#)

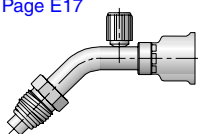

**Air Brake Jounce Line**

**17B26**  
Female - Swivel  
[Page E17](#)

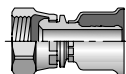

**Compressor**

**15V26**  
Female - Swivel  
45° Elbow  
[Page E17](#)

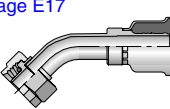

**15W26**  
Female - Swivel  
90° Elbow  
[Page E17](#)

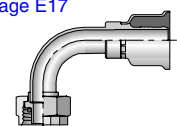

**15Z26**  
Female - Swivel  
90° Elbow - Block Type  
[Page E17](#)

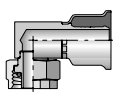

**1RV26**  
Female - Swivel  
135° Elbow  
[Page E19](#)

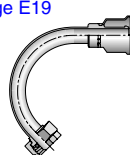

**1RZ26**  
Female - Swivel  
180° Elbow  
[Page E19](#)

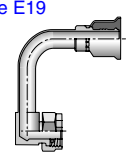

**Refrigerant Tube Mender**

**1T126**  
Male (w/Nut & Ferrule)  
[Page E19](#)

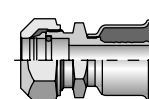

**Permanent Hose Fittings – 43 Series**

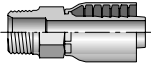
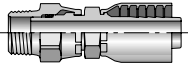
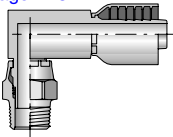
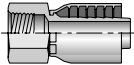
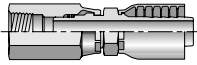
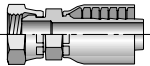
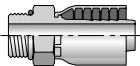
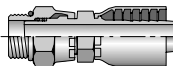
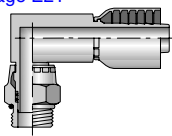
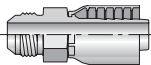
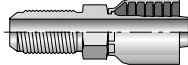
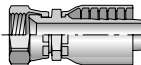
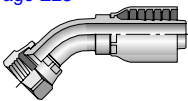
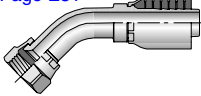
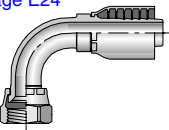
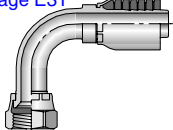
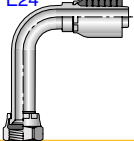
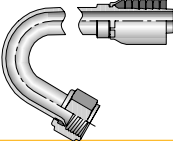
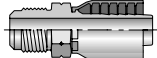
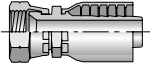
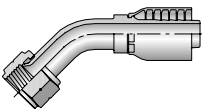
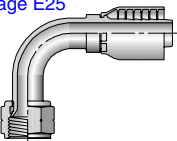
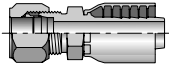
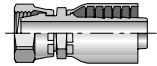
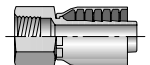
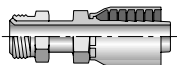
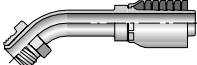
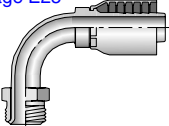
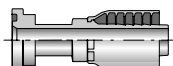
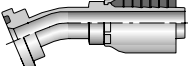
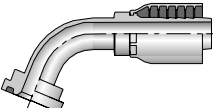
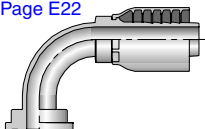
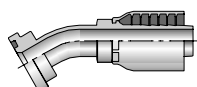
NPTF/ NPTM Pipe	10143 Male - Rigid Page E19	11343 Male - Swivel Page E22	11L43 Male - Swivel 90° Elbow Page E23	10243 Female - Rigid Page E20	1S243 Female - Swivel Page E32
					
10743 Female - Swivel Page E21	Straight Thread O-Ring	10543 Male - Rigid Page E20	10G43 Male - Swivel Page E21	10L43 Male - Swivel 90° Elbow Page E21	
					
JIC 37°	10343 Male - Rigid Page E20	11B43 Male - Bulkhead Page E32	10643 Female - Swivel Page E20	13743 Female - Swivel 45° Elbow - Short Page E23	1L743 Female - Swivel 45° Elbow - Medium Page E31
					
13943 Female - Swivel 90° Elbow - Short Page E24	1L943 Female - Swivel 90° Elbow - Short Page E31	14143 Female - Swivel 150° Elbow Page E24	14V43 Male - Swivel Page E24	SAE 45°	10443 Male - Rigid Page E20
					
10843 Female - Swivel Page E21	17743 Female - Swivel 45° Elbow Page E25	17943 Female - Swivel 90° Elbow Page E25	Flareless	11143 Male - Rigid Page E21	11243 Female - Swivel Page E21
					
1GJ43 Female - Rigid Page E29	Inverted Flare	12843 Male - Swivel Page E23	16743 Male - Swivel 45° Elbow Page E25	16943 Male - Swivel 45° Elbow Page E25	
					
Code 61 Flange	11543 Flange Head Page E22	11643 22-1/2° Elbow Page E22	11843 67-1/2° Elbow Page E22	11943 90° Elbow Page E22	12643 30° Elbow Page E23
					

**Permanent Hose Fittings – 43 Series (Continued)**

**11743**  
45° Elbow  
Page E22

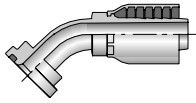

**12743**  
60° Elbow  
Page E23

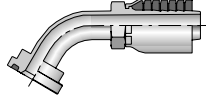

**Code 62  
Flange**

**16A43**  
Flange Head  
Page E25

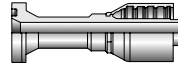

**16F43**  
45° Elbow  
Page E25

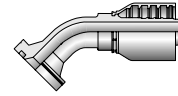

**16N43**  
90° Elbow  
Page E25

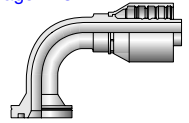

**Seal-Lok™  
(O-Ring  
Face Seal)**

**1J043**  
Male - Rigid  
w/O-Ring  
Page E29

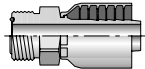

**1JB43**  
Male - Bulkhead  
w/O-Ring  
Page E30

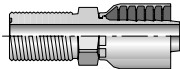

**1JC43**  
Female - Swivel Short  
Page E31

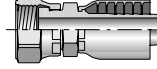

**1JS43**  
Female - Swivel Long  
Page E31

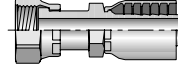

**1J643**  
Female - Swivel  
22-1/2° Elbow  
Page E31

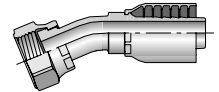

**1J743**  
Female - Swivel  
45° Elbow  
Page E30

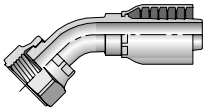

**1J943**  
Female - Swivel  
90° Elbow - Short  
Page E30

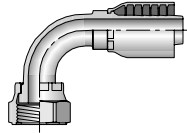

**1J543**  
Female - Swivel  
90° Elbow - Medium  
Page E29

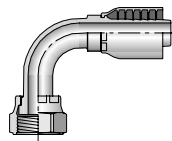

**1J143**  
Female - Swivel  
90° Elbow - Long  
Page E29

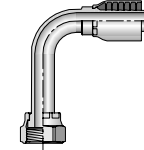

**UPTC**

**1EN**  
Male  
Page E28

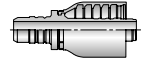

**1ET43**  
Male - 90° Elbow  
Page E28

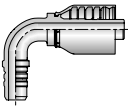

**1EU43**  
Male - 45° Elbow  
Page E28

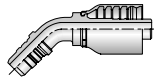

**Metric**

**1D043**  
Male - Rigid  
Page E28

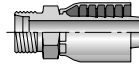

**11D43**  
Male Standpipe - Rigid  
Page E23

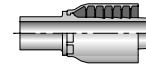

**1C343**  
Female - Swivel  
Page E26

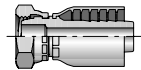

**1C443**  
Female - Swivel  
45° Elbow  
Page E26

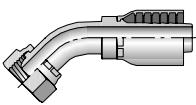

**1C543**  
Female - Swivel  
90° Elbow  
Page E26

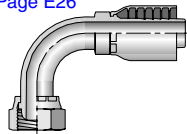

**1CA43**  
Female - Swivel  
Page E27

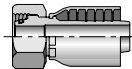

**1CE43**  
Female - Swivel  
45° Elbow  
Page E27

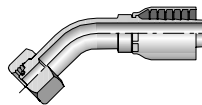

**1CF43**  
Female - Swivel  
90° Elbow  
Page E27

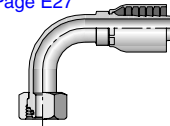

**DIN "S"  
Series &  
DIN "S"  
w/O-Ring**

**1D243**  
Male - Rigid  
Page E28

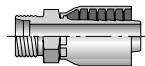

**13D43**  
Male Standpipe - Rigid  
Page E24

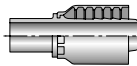

**1C643**  
Female - Swivel  
Page E27

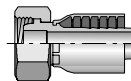

**1C943**  
Female - Swivel  
Page E27

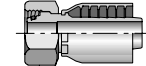

**10C43**  
Female - Swivel  
45° Elbow  
Page E21

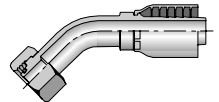

**11C43**  
Female - Swivel  
90° Elbow  
Page E23

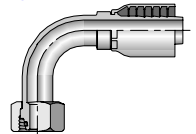

**DIN 60°  
Cone**

**1C043**  
Female - Swivel  
Page E26

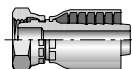

**BSP**

**1D943**  
Male - Rigid  
Page E28

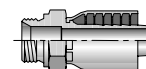

**19243**  
Female - Swivel  
Page E25

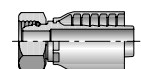

### Permanent Hose Fittings – 43 Series (Continued)

**1B143**  
Female - Swivel  
45° Elbow  
[Page E26](#)

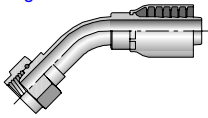

**1B243**  
Female - Swivel  
90° Elbow  
[Page E26](#)

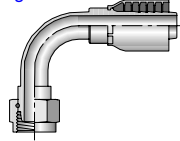

**1B443**  
Female - Swivel  
90° Elbow - Block Type  
[Page E26](#)

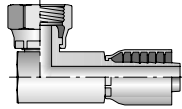

**1B543**  
Female - Swivel  
Flat Seat  
[Page E26](#)

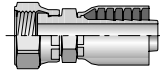

**Banjo**

**14943**  
Metric Banjo  
[Page E24](#)

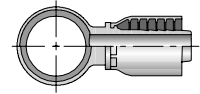

**Metric 30° Flare**

**1MU43**  
Female - Swivel  
[Page E32](#)

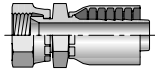

**1XU43**  
Female - Swivel  
[Page E32](#)

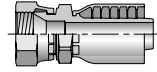

**BSP**

**1FU43**  
Female - Swivel  
[Page E28](#)

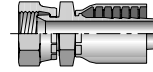

**1UT43**  
Male - Rigid  
[Page E32](#)

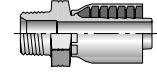

**1GU43**  
Female - Swivel  
[Page E29](#)

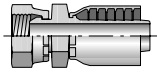

**French Gaz**

**1F443**  
Female - Swivel  
[Page E28](#)

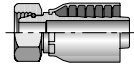

### Permanent Hose Fittings – 56 Series

**SAE & JIC Fittings**

**10356**  
Male (JIC)  
37° Rigid  
[Page E33](#)

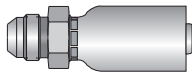

**10456**  
Male SAE 45° Rigid  
[Page E33](#)

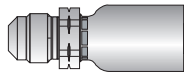

**10556**  
Male Str. Thread O-Ring  
[Page E33](#)

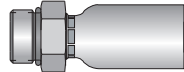

**10656**  
SAE (JIC) 37° Swivel  
[Page E33](#)

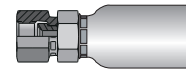

**10856**  
Female SAE 45° Swivel  
[Page E33](#)

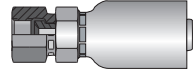

**11256**  
SAE Flareless Swivel  
[Page E34](#)

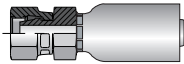

**13756**  
FM JIC 37° Swivel -  
45° Elbow  
[Page E34](#)

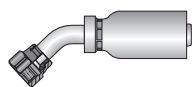

**13956**  
FM JIC 37° Swivel 90°  
Elbow Short Drop  
[Page E34](#)

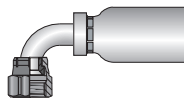

**13E56**  
Male (JIC) 37°  
Rigid Long  
[Page E34](#)

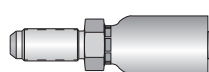

**14156**  
Female (JIC) 37° Swivel  
90° Elbow Long  
[Page E35](#)

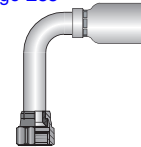

**16756**  
SAE Male Inverted  
Swivel 45° Elbow  
[Page E35](#)

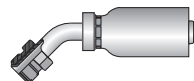

**16956**  
SAE Male Inverted  
Swivel 90° Elbow  
[Page E35](#)

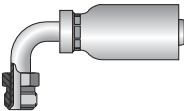

**1L956**  
Female JIC 37° Swivel  
90° Elbow - Med. Drop  
[Page E39](#)

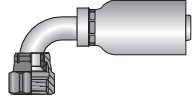

**NPTF Fittings**

**10156**  
Male Taper Pipe  
Rigid  
[Page E32](#)

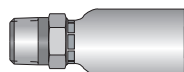

**10256**  
Female Taper Pipe  
Rigid  
[Page E32](#)

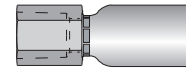

**10756**  
Female Pipe Swivel  
[Page E33](#)

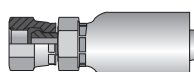

**11356**  
Male Pipe Swivel  
[Page E34](#)



**ORFS (Seal-Lok™) Fittings**

**1J056**  
Male Seal-Lok™  
Rigid Str. w/O-Ring  
[Page E38](#)

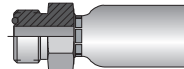

**1J156**  
Female Seal-Lok™  
90° Elbow - Long  
[Page E38](#)

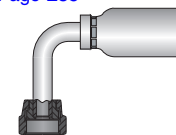

**1J256**  
Female Seal-Lok™  
30° Elbow  
[Page E38](#)

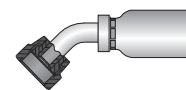

**1J556**  
Female Seal-Lok™  
90° Elbow - Med.  
[Page E38](#)

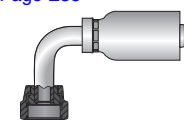



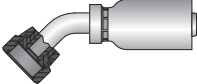
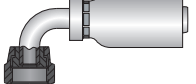
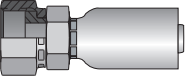
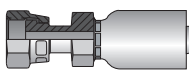
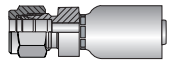
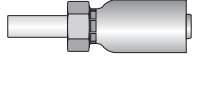
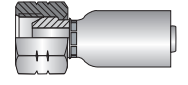
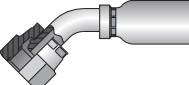
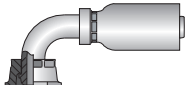
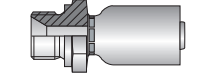
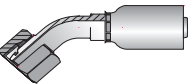
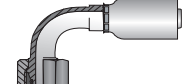
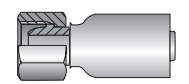
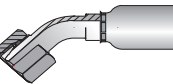
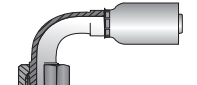
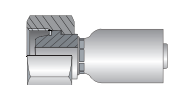
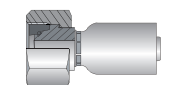
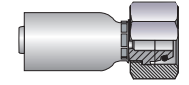
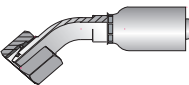
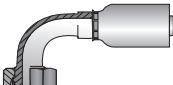
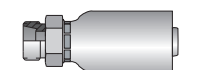
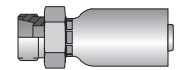



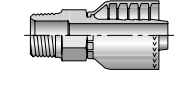
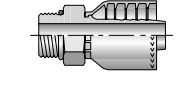
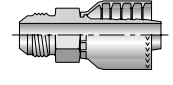
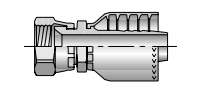
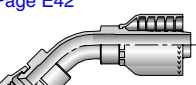
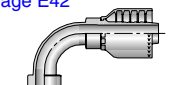
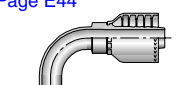
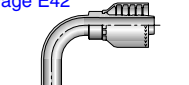



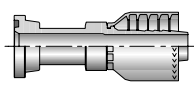
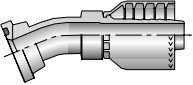
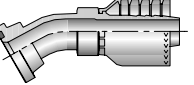
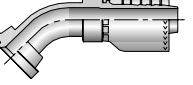
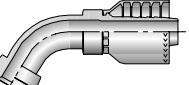
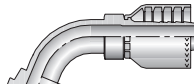
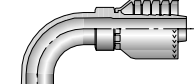
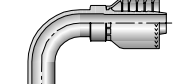
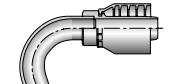
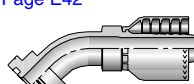
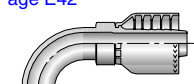

**Permanent Hose Fittings – 56 Series (Continued)**

<p><b>1J756</b> Female Seal-Lok™ 45° Elbow <a href="#">Page E38</a></p> 	<p><b>1J956</b> Female Seal-Lok™ 90° Elbow - Short <a href="#">Page E39</a></p> 	<p><b>1JC56</b> Female Seal-Lok™ Str. Swivel - Med. <a href="#">Page E39</a></p> 	<p><b>1JS56</b> Female Seal-Lok™ - Straight <a href="#">Page E39</a></p> 	<p><b>Specialty Fittings</b></p>	<p><b>1AL56</b> A-LOK Compression <a href="#">Page E35</a></p> 
<p><b>1TU56</b> Universal Inch Tube Stub End <a href="#">Page E39</a></p> 	<p><b>BSP Fittings</b></p>	<p><b>19256</b> FM BSP Parallel Pipe Swivel Str. <a href="#">Page E35</a></p> 	<p><b>1B156</b> Female BSP Pipe Swivel 45° Elbow (60° Cone) <a href="#">Page E35</a></p> 		<p><b>1B256</b> Female BSP Pipe Swivel 90° Elbow (60° Cone) <a href="#">Page E35</a></p> 
<p><b>1D956</b> Male BSPP - Str. (60° Cone) <a href="#">Page E38</a></p> 	<p><b>Metric Fittings</b></p>	<p><b>10C56</b> M FM Swivel 24° O-Ring 45° Elbow Lt. <a href="#">Page E34</a></p> 	<p><b>11C56</b> M FM Swivel 24° O-Ring 90° Elbow Lt. <a href="#">Page E34</a></p> 	<p><b>1C356</b> M FM Swivel Nut Light <a href="#">Page E36</a></p> 	<p><b>1C456</b> M FM Swivel 45° Elbow Light <a href="#">Page E36</a></p> 
<p><b>1C556</b> M FM Swivel 90° Elbow Light <a href="#">Page E36</a></p> 	<p><b>1C656</b> M FM Swivel DIN 20078 HW w/o O-Ring <a href="#">Page E36</a></p> 	<p><b>1C956</b> M FM Swivel DIN 20078 HW O-Ring <a href="#">Page E36</a></p> 	<p><b>1CA56</b> M FM Swivel 24° Light O-Ring <a href="#">Page E37</a></p> 	<p><b>1CE56</b> M FM Swivel 24° O-Ring 45° Elbow <a href="#">Page E37</a></p> 	<p><b>1CF56</b> M FM Swivel 24° O-Ring 90° Elbow <a href="#">Page E37</a></p> 
<p><b>1D056</b> M Male Stud DIN 20078 Light <a href="#">Page E37</a></p> 	<p><b>1D256</b> M Male Stud 24° Light <a href="#">Page E37</a></p> 				

**Permanent Hose Fittings – 71 Series**

<p><b>NPTF Pipe</b></p>	<p><b>10171</b> Male - Rigid <a href="#">Page E40</a></p> 	<p><b>SAE</b></p>	<p><b>10571</b> Male - Rigid <a href="#">Page E40</a></p> 	<p><b>JIC</b></p>	<p><b>10371</b> Male - Rigid <a href="#">Page E40</a></p> 
<p><b>10671</b> Female - Swivel <a href="#">Page E40</a></p> 	<p><b>13771</b> Female - Swivel 45° Elbow - Short <a href="#">Page E42</a></p> 	<p><b>13971</b> Female - Swivel 90° Elbow - Short <a href="#">Page E42</a></p> 	<p><b>1L971</b> Female - Swivel 90° Elbow - Medium <a href="#">Page E44</a></p> 	<p><b>14171</b> Female - Swivel 90° Elbow - Long <a href="#">Page E42</a></p> 	

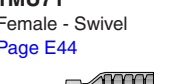
### Permanent Hose Fittings – 71 Series (Continued)

<b>Code 61 Flange</b>	<b>11571</b> Flange Page E40 	<b>11671</b> 22-1/2° Elbow Page E41 	<b>12671</b> 30° Elbow Page E41 	<b>11771</b> 45° Elbow Page E41 	<b>12771</b> 60° Elbow Page E41 
	<b>11871</b> 67-1/2° Elbow Page E41 	<b>11971</b> 90° Elbow Page E41 	<b>18971</b> 90° Elbow - Long Page E42 	<b>12U71</b> 110° Elbow Page E42 	<b>Code 62 Flange</b>
<b>16F71</b> 45° Elbow Page E42 	<b>16N71</b> 90° Elbow Page E42 	<b>Seal-Lok™ (O-Ring Face Seal)</b>	<b>1J071</b> Male - Rigid Page E43 	<b>1JC71</b> Female - Swivel - Short Page E44 	
<b>1J771</b> Female - Swivel 45° Elbow Page E44 	<b>1J971</b> Female Swivel - 90° Elbow - Short Page E44 		<b>1J571</b> Female Swivel - 90° Elbow - Medium Page E43 	<b>1J171</b> Female Swivel - 90° Elbow - Long Page E43 	<b>Metric "S"</b>
<b>1C971</b> Female - Swivel Page E43 	<b>BSP</b>	<b>1UT71</b> Male - Rigid Page E44 	<b>1GU71</b> Female - Swivel Page E43 	<b>1FU71</b> Female - Swivel Page E43 	
<b>Metric</b>		<b>1MU71</b> Female - Swivel Page E44 	<b>1XU71</b> Female - Swivel Page E45 		

### Permanent Hose Fittings – 77 Series

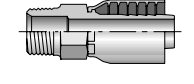
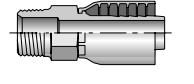
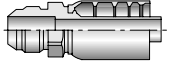
<b>NPTF Pipe</b>	<b>10177</b> Male - Rigid Page E45 	<b>API</b>	<b>1AP77</b> Male - Rigid Page E49 	<b>JIC 37°</b>	<b>10377</b> Male - Rigid Page E45 



**Permanent Hose Fittings – 77 Series (Continued)**

**10677**

Female - Swivel  
Straight  
[Page E45](#)

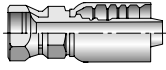

**13777**

Female - Swivel  
45° Elbow - Short  
[Page E47](#)

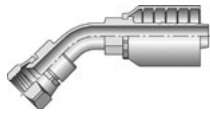

**13977**

Female - Swivel  
90° Elbow - Short  
[Page E47](#)

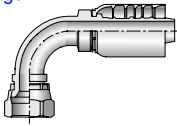

**14177**

Female - Swivel  
90° Elbow - Long  
[Page E47](#)

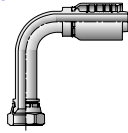

**Straight Thread O-Ring**

**10577**

Male - Rigid  
[Page E45](#)

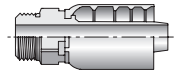

**Full Flange**

**1X577**

Full Flange - Straight  
[Page E51](#)

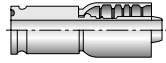

**1X777**

45° Elbow  
[Page E51](#)

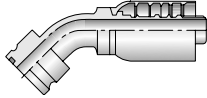

**1X977**

90° Elbow  
[Page E51](#)

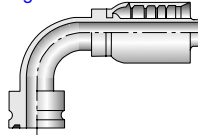

**Flange Code 61**

**11577**

Code 61 - Straight  
[Page E46](#)

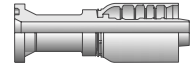

**14A77**

Code 61 - Straight  
[Page E47](#)

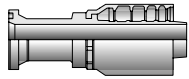

**11677**

Code 61  
22-1/2° Elbow  
[Page E46](#)

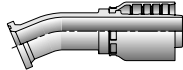

**14B77**

Code 61  
22-1/2° Elbow  
[Page E47](#)

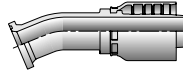

**12677**

Code 61 - 30° Elbow  
[Page E46](#)

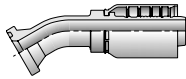

**11777**

Code 61 - 45° Elbow  
[Page E46](#)



**14F77**

Code 61 - 45° Elbow  
[Page E47](#)

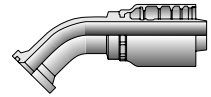

**12777**

Code 61 - 60° Elbow  
[Page E46](#)

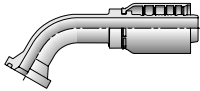

**14G77**

Code 61 - 60° Elbow  
[Page E47](#)

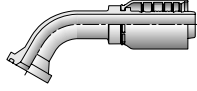

**18777**

Code 61 -  
67-1/2° Elbow  
[Page E46](#)

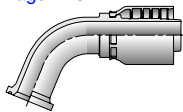

**11977**

Code 61 - 90° Elbow  
[Page E46](#)

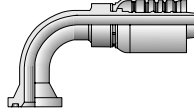

**14N77**

Code 61 - 90° Elbow  
[Page E48](#)

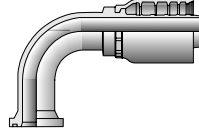

**Flange Code 62**

**16A77**

Code 62 - Straight  
[Page E48](#)

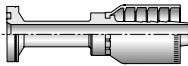

**16B77**

Code 62  
22-1/2° Elbow  
[Page E48](#)

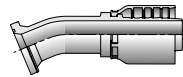

**16E77**

Code 62 - 30° Elbow  
[Page E48](#)

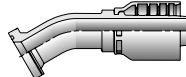

**16F77**

Code 61 - 45° Elbow  
[Page E48](#)

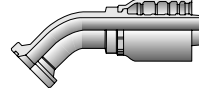

**16G77**

Code 62 - 60° Elbow  
[Page E48](#)

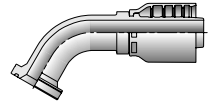

**16N77**

Code 62 - 90° Elbow  
[Page E48](#)

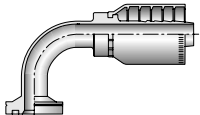

**Caterpillar® Flange**

**1XA77**

Caterpillar® - Flange  
[Page E51](#)

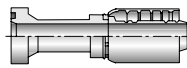

**1XB77**

Caterpillar® Flange  
22-1/2° Elbow  
[Page E51](#)

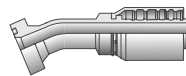

**1XE77**

Caterpillar® Flange  
30° Elbow  
[Page E51](#)

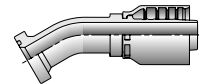

**1XF77**

Caterpillar® Flange  
45° Elbow  
[Page E51](#)

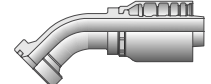

**1XG77**

Caterpillar® Flange  
60° Elbow  
[Page E52](#)

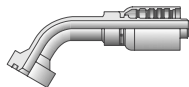

**1XM77**

Caterpillar® Flange  
67-1/2° Elbow  
[Page E52](#)

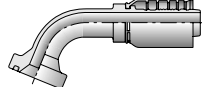

**1XN77**

Caterpillar® Flange  
90° Elbow  
[Page E52](#)

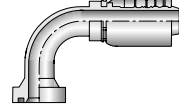

**Komatsu® Flange**

**1K577**

Komatsu® Flange  
Straight  
[Page E50](#)

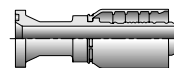

**1K777**

Komatsu® Flange  
45° Elbow  
[Page E50](#)

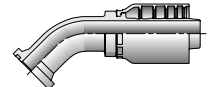

**1K977**

Komatsu® Flange  
90° Elbow  
[Page E51](#)

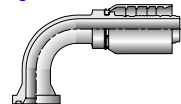

**Seal-Lok™**

**1JC77**

Female - Swivel  
Straight - Short  
[Page E50](#)

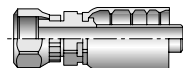

**1JS77**

Female - Swivel  
Straight - Long  
[Page E50](#)

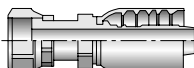

**1J077**

Male - Rigid  
w/O-Ring  
[Page E49](#)

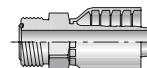

**1J777**

Female - Swivel  
45° Elbow  
[Page E50](#)

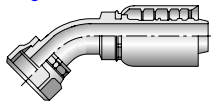

### Permanent Hose Fittings – 77 Series (Continued)

**1J977**  
Female - Swivel  
90° Elbow - Short  
[Page E50](#)

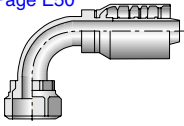

**1J577**  
Female - Swivel  
90° Elbow - Medium  
[Page E50](#)

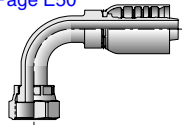

**1J177**  
Female - Swivel  
90° Elbow - Long  
[Page E49](#)

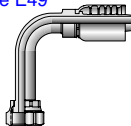

**DIN "S" Series w/O-Ring**

**1D277**  
Male Metric S  
Rigid - 24° Cone  
[Page E49](#)

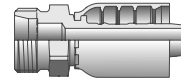

**1C977**  
Female - Swivel  
Straight  
[Page E49](#)

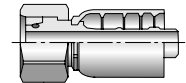

**10C77**  
Female Metric S  
Swivel - 45° Elbow  
[Page E45](#)

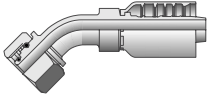

**11C77**  
Female - Swivel  
90° Elbow  
[Page E46](#)

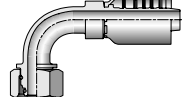

**BSP**

**1FU77**  
Female - Swivel  
Straight - 30° Flare  
[Page E49](#)

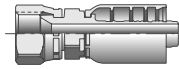

**1GU77**  
Female - Swivel  
Straight - 60° Cone  
[Page E49](#)

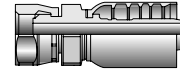

**24° Cone**

**1ZM77**  
Male 24° Cone  
[Page E52](#)

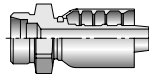

### Permanent Hose Fittings – 79 Series

**Code 62 Flange**

**16A79**  
Flange  
[Page E52](#)

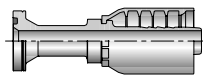

**16F79**  
45° Elbow  
[Page E52](#)

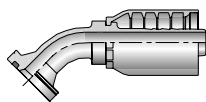

**16G79**  
60° Elbow  
[Page E52](#)

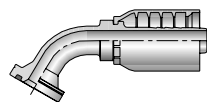

**16N79**  
90° Elbow  
[Page E52](#)

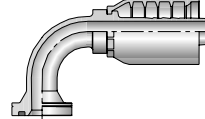

**Seal-Lok™ (O-Ring Face Seal)**

**1JS79**  
Female - Swivel  
Long  
[Page E53](#)

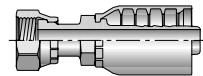

**1J779**  
Female - Swivel  
45° Elbow  
[Page E53](#)

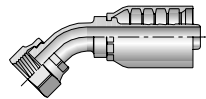

**1J979**  
Female - Swivel  
90° Elbow - Short  
[Page E53](#)

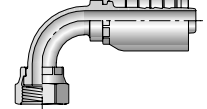

**Flange Head**

**1XA79**  
Flange Head  
[Page E53](#)

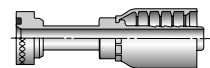

**1XF79**  
45° Elbow  
[Page E53](#)

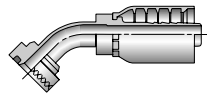

**1XN79**  
90° Elbow  
[Page E53](#)

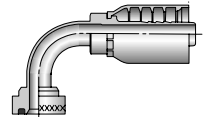

### Permanent Hose Fittings – 81Series

**81 Series Crimp Shell**

**10081**  
Crimp Shell  
[Page E53](#)



81 Series consists of a 10081 crimp shell and is completed by adding any 88 Series fittings. See pages D19 and D20 for Series 88 fittings.

**Permanent Hose Fittings – 91N/91Series**

**91N/91 Series**

**10191/10191N**  
Male Taper Pipe Rigid  
Page E54

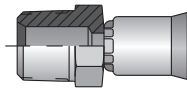

**10391**  
Male JIC 37°  
Page E54

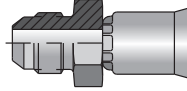

**10691**  
JIC 37° Female Swivel  
Page E54

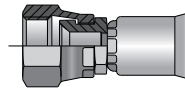

**10791**  
Female Pipe Swivel  
Page E54

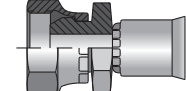

**10891**  
Female SAE 45° Swivel  
Page E54

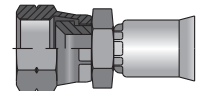

**12891**  
Male Inverted Swivel  
Straight  
Page E54

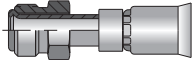

**13491**  
Straight Tube  
Page E54

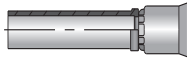

**13791**  
Female JIC 37°  
Swivel 45° Elbow  
Page E55

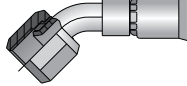

**13991**  
Female JIC 37°  
Swivel 90° Elbow  
Page E55

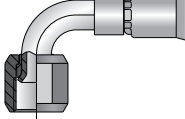

**14191**  
Female JIC 37°  
Swivel 90° Elbow Long  
Page E55

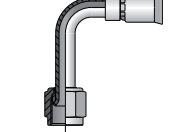

**16191N**  
Compression Air Brake  
Page I17

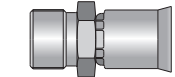

**16791**  
SAE Male Inverted  
45° Elbow  
Page E55

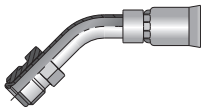

**16991**  
SAE Male Inverted  
90° Elbow  
Page E55

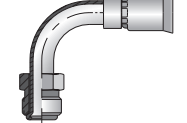

**17791**  
SAE 45° Swivel  
45° Elbow  
Page E56

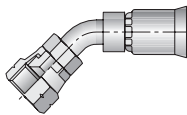

**17991**  
Female SAE 45° Swivel  
90° Elbow  
Page E56

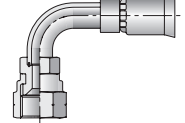

**19291**  
Female BSP Pipe Swivel  
Str. (60° Cone)  
Page E56

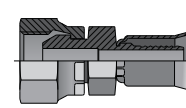

**1B291**  
Female BSP Pipe  
Swivel 45° Elbow  
(60° Cone)  
Page E56

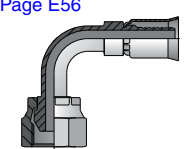

**1J191**  
Female Seal-Lok™  
90° Elbow Long  
Page E56

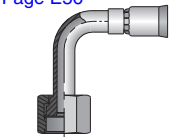

**1J791**  
Female Seal-Lok™  
45° Elbow  
Page E57

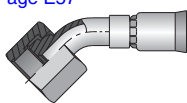

**1J991**  
Female Seal-Lok™  
90° Elbow  
Page E57

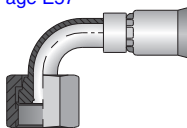

**1JC91**  
Female Seal-Lok™  
Swivel Straight Short  
Page E57

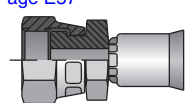

**1TU91**  
Universal Tube Stub End  
Page E57

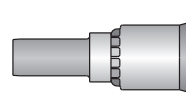

**Permanent Hose Fittings – 93 Series**

**93N Series**

**10193N**  
Male Taper Pipe Rigid  
Page E57

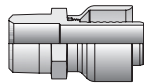

**10693N**  
Female JIC 37° Swivel  
Page E57

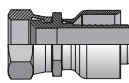

**13793N**  
Female JIC 37°  
Swivel 45° Elbow  
Page E58

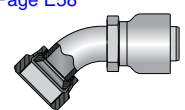

**13993N**  
Female JIC 37°  
Swivel 90° Elbow  
Page E58

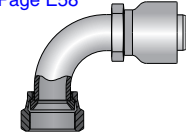

**14K93N**  
ANSI B16.5 Flange  
Page E58

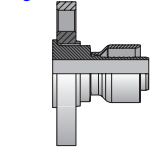

**1J793N**  
Female Seal-Lok™  
45° Elbow  
Page E58

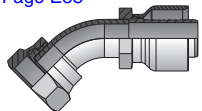

**1J993N**  
Female Seal-Lok™  
90° Elbow  
Page E58

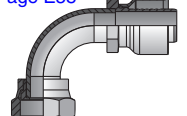

**1JC93N**  
Female Seal-Lok™  
Swivel Straight Short  
Page E58

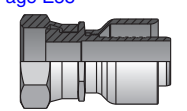

**Permanent Hose Fittings – CY Series**

**CY Series**

**101CY**  
Male Taper Pipe Rigid  
Page E58

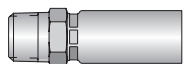

**102CY**  
Female Pipe Thread  
Page E58

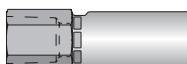

**106CY**  
JIC 37° Female  
Swivel  
Page E59

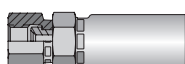

**113CY**  
Male Pipe Swivel  
Page E59

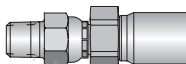

**139CY**  
Female JIC 37°  
Swivel 90° Elbow  
Page 59

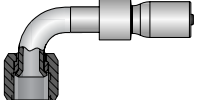

### Permanent Hose Fittings – CY Series (Continued)

**1GKCY**

Bulkhead w/Zerk  
Port Integrated  
[Page E59](#)

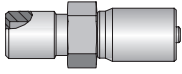

**1J9CY**

Female Seal-Lok™  
90° Elbow  
[Page E59](#)

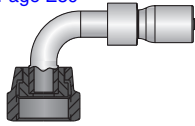

**1JCCY**

Female Seal-Lok™  
Swivel Straight Short  
[Page E59](#)

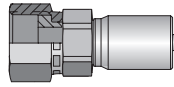

**1LMCY**

Male Grease  
[Page E59](#)

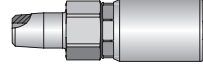

### Permanent Hose Fittings – HY Series

**NPTF Pipe**

**101HY**

Male - Rigid  
[Page E60](#)

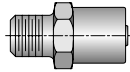

**113HY**

Male - Swivel  
[Page E62](#)

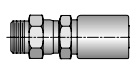

**11LHY**

Male - Swivel  
90° Elbow  
[Page E62](#)

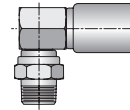

**102HY**

Female - Rigid  
[Page E60](#)

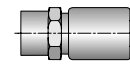

**NPSM Pipe**

**107HY**

Female - Swivel  
(60° Cone)  
[Page E61](#)

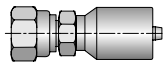

**Straight Thread**

**105HY**  
Male - Rigid  
[Page E60](#)

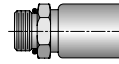

**10GHY**  
Male - Swivel  
[Page E61](#)

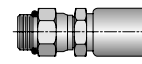

**10LHY**  
Swivel - Swivel  
90° Elbow  
[Page E61](#)

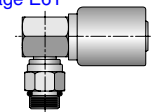

**JIC 37°**

**103HY**

Male - Rigid  
[Page E60](#)

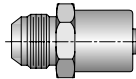

**106HY**

Female - Swivel  
[Page E61](#)

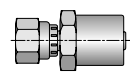

**137HY**

Female - Swivel  
45° Elbow - Short  
[Page E62](#)

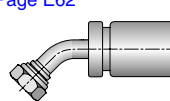

**139HY**

Female - Swivel  
90° Elbow - Short  
[Page E63](#)

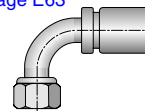

**141HY**

Female - Swivel  
45° Elbow - Long  
[Page E63](#)

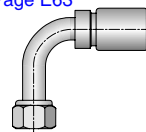

**193HY**

Female - Swivel  
90° Elbow - Block  
[Page E63](#)

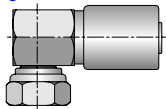

**SAE 45°**

**108HY**

Female - Swivel  
[Page E61](#)

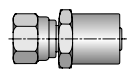

**177HY**

Female - Swivel  
45° Elbow  
[Page E63](#)

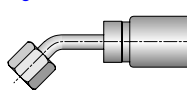

**179HY**

Female - Swivel  
90° Elbow  
[Page E63](#)

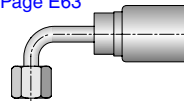

**Flareless**

**111HY**

Male - Rigid  
[Page E62](#)

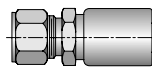

**Grease Connection**

**1GJHY**  
Female - Rigid  
[Page E64](#)

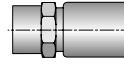

**Standpipe**

**134HY**  
Male Standpipe Rigid  
[Page E62](#)

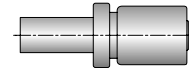

**Inverted Flare**

**128HY**

Male - Swivel  
[Page E62](#)

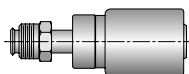

**167HY**

Male - Swivel  
45° Elbow  
[Page E63](#)

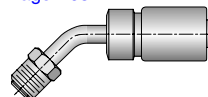

**169HY**

Male - Swivel  
90° Elbow  
[Page E63](#)

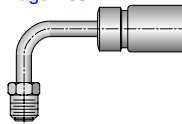

**129HY**

Female - Rigid  
[Page E62](#)

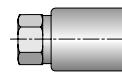

**Permanent Hose Fittings – HY Series (Continued)**

**Seal-Lok®  
(O-Ring  
Face Seal)**

**1J0HY**  
Male - Rigid  
w/O-Ring  
[Page E64](#)

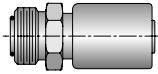

**1JCHY**  
Female - Swivel  
Short  
[Page E65](#)

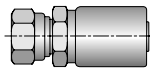

**1JSHY**  
Female - Swivel  
Long  
[Page E65](#)

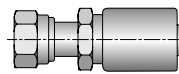

**1J7HY**  
Female - Swivel  
45° Elbow  
[Page E64](#)

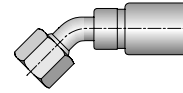

**1J9HY**  
Female - Swivel  
90° Elbow - Short  
[Page E65](#)

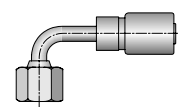

**1J1HY**  
Female - Swivel  
90° Elbow - Long  
[Page E64](#)

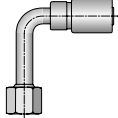

**Metric  
L & S**

**1D0HY**  
Male - Rigid  
[Page E64](#)



**13DHY**  
Male Standpipe Rigid  
[Page E63](#)



**BSP**

**1D9HY**  
Male - Rigid  
[Page E64](#)



**1GUHY**  
Female - Swivel  
[Page E64](#)

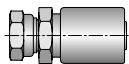

**1UTHY**  
Male - Rigid  
[Page E65](#)

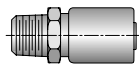

**1XUHY**  
Female - Metric Swivel  
[Page E65](#)

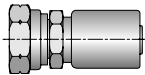

**Permanent Hose Fittings – SF Series**

**SF Series**

**101SF**  
Male Taper Pipe Rigid  
[Page E65](#)

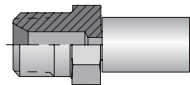

**106SF**  
JIC 37° Swivel  
[Page E65](#)

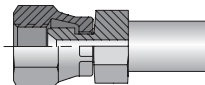

**1JSSF**  
Female Seal-Lok™  
Swivel Long  
[Page E66](#)

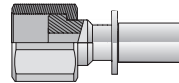

**1JBSF**  
Male Seal-Lok™  
Bulkhead w/O-Ring  
[Page E65](#)

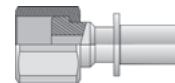

## 25 Series

### 10125

Male NPTF Pipe - Rigid

Part Number	Thread inch	Hose ID inch
10125-6-6B-VS	3/8x18	3/8
10125-6-8B-VS	3/8x18	1/2
10125-8-6B-VS	1/2x14	3/8
10125-8-8B-VS	1/2x14	1/2

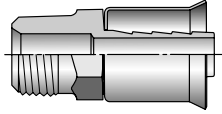

### 10825

Female SAE 45° - Swivel

Part Number	Thread inch	Hose ID inch
10825-6-6B	5/8x18	3/8
10825-8-6B	3/4x16	3/8
10825-8-8B	3/4x16	1/2

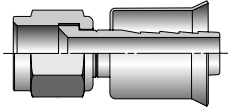

## 26 Series

### 10126

Male NPTF Pipe - Rigid

Part Number	Thread inch	Hose ID inch
10126-2-4	1/8x27	3/16
10126-4-4	1/4x18	3/16
10126-4-5	1/4x18	1/4
10126-4-6	1/4x18	5/16
10126-6-6	3/8x18	5/16
10126-6-8	3/8x18	13/32
10126-8-8	1/2x14	13/32
10126-8-10	1/2x14	1/2
10126-12-12	3/4x14	5/8
10126-16-16	1x11-1/2	7/8
10126-20-20	1-1/4x11-1/2	1-1/8
10126-24-24	1-1/2x11-1/2	1-3/8
10126-32-32	2x11-1/2	1-13/16

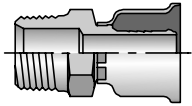

### 10326

Male JIC 37° - Rigid

Part Number	Thread inch	Hose ID inch
10326-4-4	1/4 7/16x20	3/16
10326-6-6	3/8 9/16x18	5/16
10326-8-8	1/2 3/4x16	13/32
10326-10-10	5/8 7/8x14	1/2
10326-16-16	1 1-5/16x12	7/8
10326-20-16	1-1/4 1-5/8x12	7/8
10326-20-20	1-1/4 1-5/8x12	1-1/8

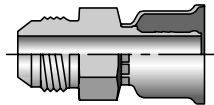

### 10426

Male SAE 45° - Rigid

Part Number	Thread inch	Hose ID inch
10426-4-4	1/4 7/16x20	3/16

Notch on nut signifies SAE 45° flare fitting.

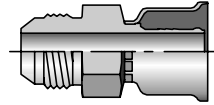

### 10626

Female JIC 37° - Swivel

Part Number	Thread inch	Hose ID inch
10626-6-6	3/8 9/16x18	5/16
10626-6-8	3/8 9/16x18	13/32
10626-12-12	3/4 1-1/16x12	5/8
10626-16-16	1 1-5/16x12	7/8
10626-20-20	1-1/4 1-5/8x12	1-1/8
10626-24-24	1-1/2 1-7/8x12	1-3/8
10626-32-32	2 2-1/2x12	1-13/16

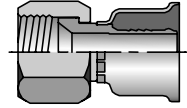

### 10826

Female SAE 45° - Swivel

Part Number	Thread inch	Hose ID inch
10826-6-6	3/8 5/8x18	5/16
10826-10-8	5/8 7/8x14	13/32
10826-10-10	5/8 7/8x18	1/2
10826-12-12	3/4 1-1/16x14	5/8

Notch on nut signifies SAE 45° flare fitting.

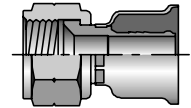

### 12826

Male Inverted SAE 45° - Swivel

Part Number	Thread inch	Hose ID inch
12826-4-4	1/4 7/16x24	3/16
12826-5-5	5/16 1/2x20	1/4
12826-6-6	3/8 5/8x18	5/16
12826-8-8	1/2 3/4x18	13/32
12826-10-10	5/8 7/8x18	1/2

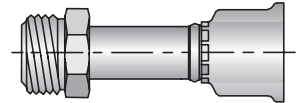

25 Series: Use with [271 hose](#).

26 Series: Use with [201](#), [206](#), [213](#), [221FR](#), [244](#), [266](#), [285](#), [293](#), [SS23CG](#) hoses.

Dimensions and pressures are for reference only and are subject to change.

### 13726

Female JIC 37° - Swivel - 45° Elbow - Short Drop

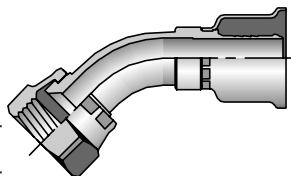

Part Number	Thread inch	Hose ID inch
13726-4-4	1/4 7/16x20	3/16
13726-6-6	3/8 9/16x18	5/16
13726-8-8	1/2 3/4x16	13/32
13726-10-10	5/8 7/8x14	1/2
13726-10-12	5/8 7/8x14	5/8
13726-12-12	3/4 1-1/16x12	5/8
13726-16-16	1 1-5/16x12	7/8
13726-20-20	1-1/4 1-5/8x12	1-1/8
13726-24-24	1-1/2 1-7/8x12	1-3/8

### 13926

Female JIC 37° - Swivel - 90° Elbow - Short Drop

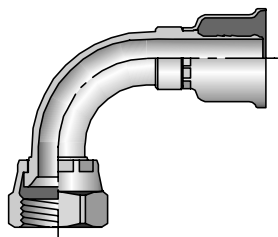

Part Number	Thread inch	Hose ID inch
13926-4-4	1/4 7/16x20	3/16
13926-6-6	3/8 9/16x18	5/16
13926-8-8	1/2 3/4x16	13/32
13926-10-10	5/8 7/8x14	1/2
13926-10-12	5/8 7/8x14	5/8
13926-12-12	3/4 1-1/16x12	5/8
13926-16-16	1 1-5/16x12	7/8
13926-20-20	1-1/4 1-5/8x12	1-1/8
13926-24-24	1-1/2 1-7/8x12	1-3/8

### 14126

Female JIC 37° - Swivel - 90° Elbow - Long Drop

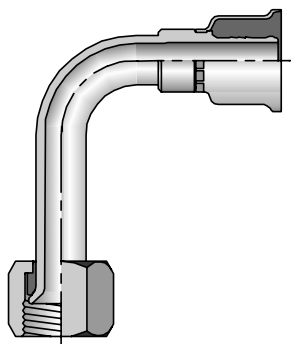

Part Number	Thread inch	Hose ID inch
14126-4-4	1/4 7/16x20	1/4
14126-6-6	3/8 9/16x18	5/16
14126-8-8	1/2 3/4x16	13/32
14126-10-10	5/8 7/8x14	1/2
14126-12-12	3/4 1-1/16x12	5/8
14126-16-16	1 1-5/16x12	7/8

Notch on nut signifies SAE 45° flare fitting.

### 14526-PR

Male Tube-O - Swivel - Long Pilot With Charge Port for R12

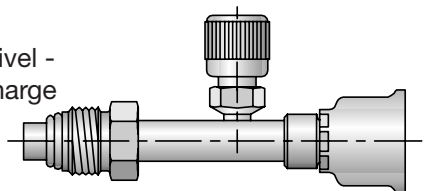

Part Number	Thread inch	Hose ID inch
14526-6-6-PR	3/8 5/8x18	5/16

### 14526-PT

Male Tube-O - Swivel - Long Pilot With Low Pressure Charge Port for R134a

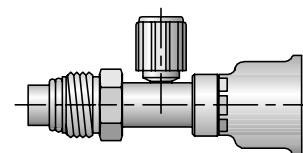

Part Number	Thread inch	Hose ID inch
14526-10-12-PT	5/8 7/8x18	5/8

### 15926-PB

Female Tube-O - Swivel - Long Pilot With High Pressure Charge Port for R134a

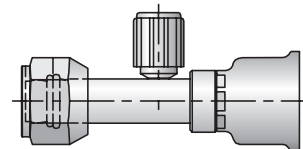

Part Number	Thread inch	Hose ID inch
15926-6-6-PB	3/8 5/8x18	5/16
15926-8-8-PB	1/2 3/4x16	13/32

### 15926-PT

Female Tube-O - Swivel - Long Pilot With Low Pressure Charge Port for R134a

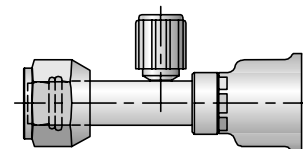

Part Number	Thread inch	Hose ID inch
15926-10-12-PT	5/8 7/8x14	5/8

### 15G26

Male Tube-O - Rigid - Internal Long Pilot (3-Step)

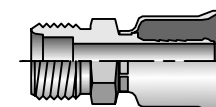

Part Number	Thread inch	Hose ID inch
15G26-6-6	3/8 5/8x18	3/8
15G26-8-8	1/2 3/4x16	13/32
15G26-10-10	5/8 7/8x14	1/2
15G26-10-12	5/8 7/8x14	5/8

### 15G26-PR

Male Tube-O - Rigid - Internal Long Pilot (3-Step) With Charge Port for R12

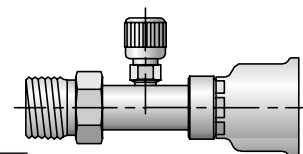

Part Number	Thread inch	Hose ID inch
15G26-10-12-PR	5/8 7/8x14	5/8

26 Series: Use with 201, 206, 213, 221FR, 244, 266, 285, 293, SS23CG hoses.  
Dimensions and pressures are for reference only and are subject to change.

### 15H26

Female Tube-O - Swivel -  
45° Elbow - Short Pilot

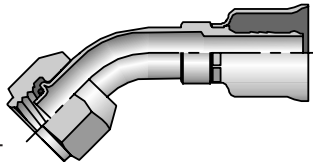

Part Number	Thread inch	Hose ID inch
15H26-6-6	3/8 5/8x18	5/16
15H26-8-8	1/2 3/4x16	13/32
15H26-10-10	5/8 7/8x14	1/2
15H26-10-12	5/8 7/8x14	3/4

### 15K26

Male Tube-O - Swivel -  
90° Elbow - Short Pilot

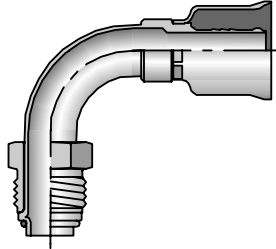

Part Number	Thread inch	Hose ID inch
15K26-6-6	3/8 5/8X18	5/16
15K26-7-6	7/16 11/16x16	5/16
15K26-8-8	1/2 3/4x18	13/32
15K26-10-10	5/8 7/8x18	1/2
15K26-10-12	5/8 7/8x18	5/8

### 15K26-PB

Male Tube-O - Swivel -  
90° Elbow - Short Pilot  
with High Pressure Charge  
Port for R134a

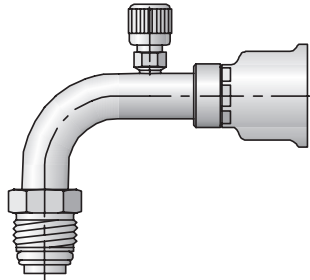

Part Number	Thread inch	Hose ID inch
15K26-8-8-PB	1/2 3/4x16	13/32

### 15K26-PR

Male Tube-O - Swivel -  
90° Elbow - Short Pilot with  
Charge Port for R12

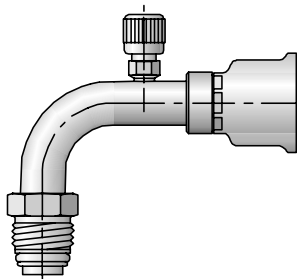

Part Number	Thread inch	Hose ID inch
15K26-10-10-PR	5/8 7/8x18	1/2
15K26-10-12-PR	5/8 7/8x18	5/8

### 15L26

Female Tube-O - Swivel -  
90° Elbow - Long Pilot

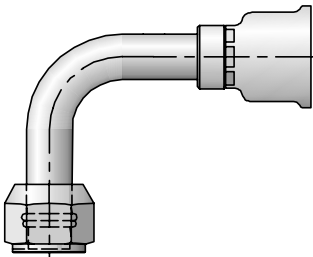

Part Number	Thread inch	Hose ID inch
15N26-10-12-PT	5/8 7/8x14	5/8

### 15L26-PB

Female Tube-O - Swivel -  
90° Elbow - Long Pilot With  
High Pressure Charge Port  
for R134a

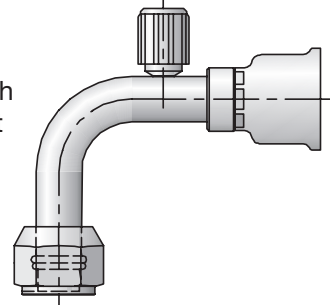

Part Number	Thread inch	Hose ID inch
15L26-6-6-PB	3/8 5/8x18	5/16
15L26-8-8-PB	1/2 3/4x16	13/32

### 15L26-PR

Female Tube-O - Swivel -  
90° Elbow - Long Pilot With  
Charge Port for R12

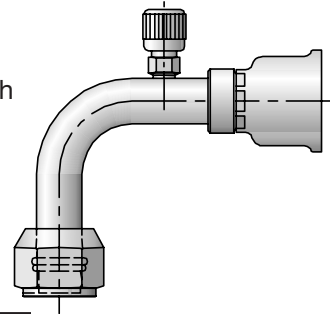

Part Number	Thread inch	Hose ID inch
15L26-8-8-PR	1/2 3/4x16	13/32
15L26-10-10-PR	5/8 7/8x14	1/2
15L26-10-12-PR	5/8 7/8x14	5/8

### 15L26-PT

Female Tube-O - Swivel -  
90° Elbow - Long Pilot With  
Low Pressure Charge Port  
for R134a

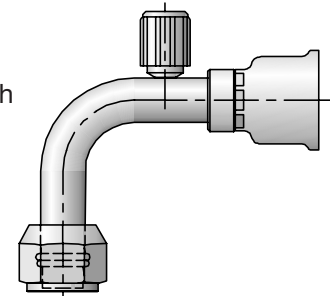

Part Number	Thread inch	Hose ID inch
15L26-10-10-PT	5/8 7/8X14	1/2
15L26-10-12-PT	5/8 7/8x14	5/8
15L26-12-12-PT	3/4 1-1/16x14	5/8

### 15M26-PR

Male Tube-O - Swivel -  
90° Elbow - Long Pilot With  
Charge Port for R12

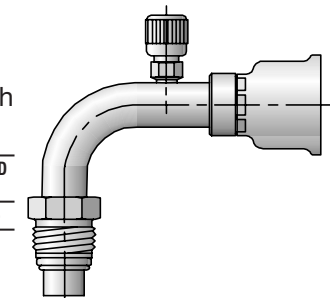

Part Number	Thread inch	Hose ID inch
15M26-6-6-PR	3/8 5/8x18	5/16

26 Series: Use with [201](#), [206](#), [213](#), [221FR](#), [244](#), [266](#), [285](#), [293](#), [SS23CG](#) hoses.  
Dimensions and pressures are for reference only and are subject to change.



### 15M26-PT

Male Tube-O - Swivel - 90° Elbow - Long Pilot With Low Pressure Charge Port for R134a

Part Number	Thread inch	Hose ID inch
15M26-10-12-PT	5/8 7/8x18	5/8

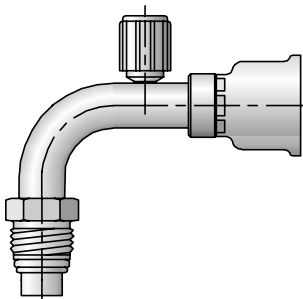

### 15S26

Female Tube-O - Swivel - Short Pilot

Part Number	Thread inch	Hose ID inch
15S26-6-6	3/8 5/8x18	5/16
15S26-8-8	1/2 3/4x16	13/32
15S26-10-10	5/8 7/8x14	1/2
15S26-10-12	5/8 7/8x14	5/8
15S26-12-12	3/4 1-1/16x14	5/8

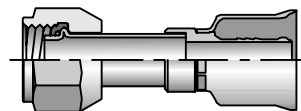

### 15N26-PB

Female Tube-O - Swivel - 45° Elbow - Long Pilot With High Pressure Charge Port for R134a

Part Number	Thread inch	Hose ID inch
15N26-10-12-PT	5/8 7/8x14	5/8

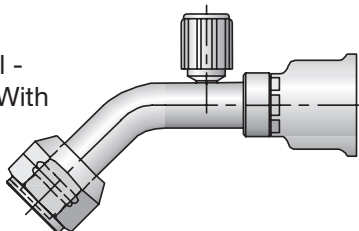

### 15T26

Female Tube-O - Swivel - 90° Elbow - Short Pilot

Part Number	Thread inch	Hose ID inch
15T26-6-6	3/8 5/8x18	5/16
15T26-8-8	1/2 3/4x16	13/32
15T26-10-10	5/8 7/8x14	1/2
15T26-10-12	5/8 7/8x14	5/8
15T26-12-12	3/4 1-1/16x14	5/8

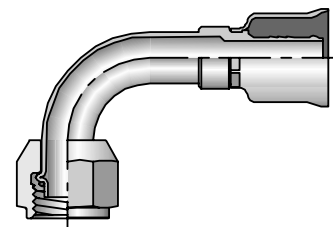

### 15N26-PT

Female Tube-O - Swivel - 45° Elbow - Long Pilot With Low Pressure Charge Port for R134a

Part Number	Thread inch	Hose ID inch
15N26-10-12-PT	5/8 7/8x14	5/8

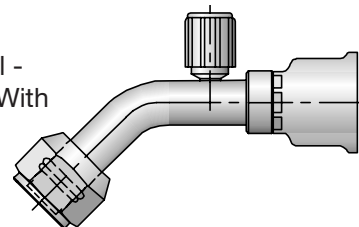

### 15V26

Female Compressor - Swivel - 45° Elbow

Part Number	Thread inch	Hose ID inch
15V26-12-8	1x14	13/32
15V26-12-12	1x14	5/8

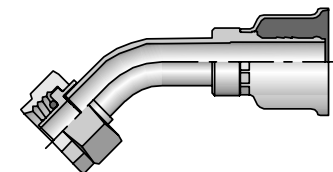

### 15P26-PT

Male Tube-O - Swivel - 45° Elbow - Long Pilot With Low Pressure Charge Port for R134a

Part Number	Thread inch	Hose ID inch
15P26-10-12-PT	5/8 7/8x18	5/8

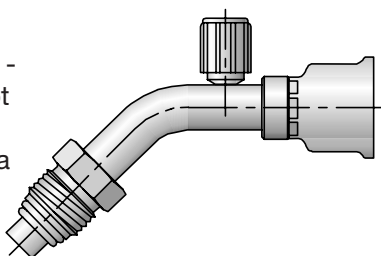

### 15W26

Female Compressor - Swivel - 90° Elbow

Part Number	Thread inch	Hose ID inch
15W26-12-8	1x14	13/32
15W26-12-12	1x14	5/8

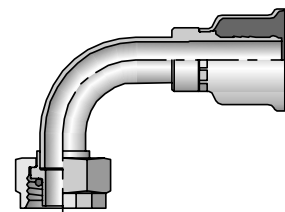

### 15R26

Male Tube-O - Swivel - 45° Elbow - Short Pilot

Part Number	Thread inch	Hose ID inch
15R26-6-6	3/8 5/8x18	5/16
15R26-7-6	7/16 11/16x16	5/16
15R26-8-8	1/2 3/4x18	13/32
15R26-10-10	5/8 7/8x18	1/2
15R26-10-12	5/8 7/8x18	5/8

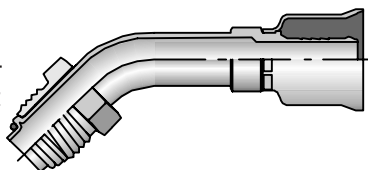

### 15Z26

Female Compressor - Swivel - 90° Elbow - Block Type

Part Number	Thread inch	Hose ID inch
15Z26-12-8	1X14	13/32
15Z26-12-12	1X14	5/8

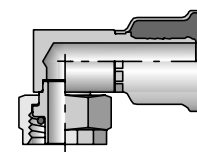

26 Series: Use with 201, 206, 213, 221FR, 244, 266, 285, 293, SS23CG hoses.  
Dimensions and pressures are for reference only and are subject to change.

### 16726

Male Inverted SAE 45° - Swivel - 45° Elbow

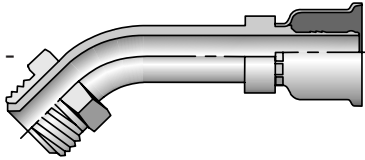

Part Number	Thread inch	Hose ID inch
16726-4-4	1/4 7/16x24	3/16
16726-5-5	5/16 1/2x20	1/4
16726-6-6	3/8 5/8x18	5/16
16726-8-8	1/2 3/4x18	13/32

### 16826

Female JIC 37° / SAE 45° - Dual Flare - Swivel

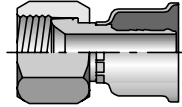

Part Number	Thread inch	Hose ID inch
16826-4-4	1/4 7/16x20	3/16
16826-4-5	1/4 7/16x20	1/4
16826-5-5	5/16 1/2x20	1/4
16826-8-6	1/2 3/4x16	5/16
16826-8-8	1/2 3/4x16	13/32
16826-8-10	1/2 3/4x16	1/2
16826-10-10	5/8 7/8x14	1/2
16826-10-12	5/8 7/8x14	5/8

### 16926

Male Inverted SAE 45° - Swivel - 90° Elbow

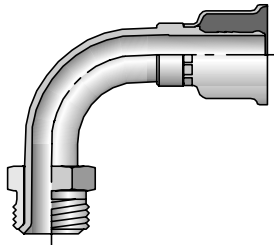

Part Number	Thread inch	Hose ID inch
16926-4-4	1/4 7/16x24	3/16
16926-5-5	5/16 1/2x20	1/4
16926-6-6	3/8 5/8x18	5/16
16926-8-8	1/2 3/4x18	13/32
16926-10-10	5/8 7/8x18	1/2

### 17726

Female SAE 45° - Swivel - 45° Elbow

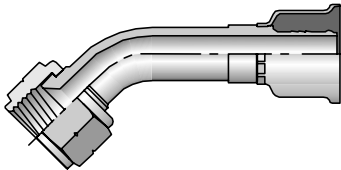

Part Number	Thread inch	Hose ID inch
17726-4-4	1/4 7/16x20	3/16
17726-6-6	3/8 5/8x18	5/16
17726-8-8	1/2 3/4x16	13/32
17726-10-10	5/8 7/8x14	1/2
17726-10-12	5/8 7/8x14	5/8
17726-12-12	3/4 1-1/16x14	5/8

Notch on nut signifies SAE 45° flare fitting.

### 17926

Female SAE 45° - Swivel - 90° Elbow

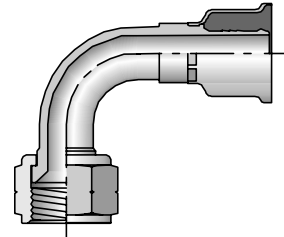

Part Number	Thread inch	Hose ID inch
17926-4-4	1/4 7/16x20	3/16
17926-6-6	3/8 5/8x18	5/16
17926-8-8	1/2 3/4x16	13/32
17926-10-10	5/8 7/8x14	1/2
17926-10-12	5/8 7/8x14	5/8
17926-12-12	3/4 1-1/16x14	5/8

Notch on nut signifies SAE 45° flare fitting.

### 1J726

Female Seal-Lok™ - Swivel - 45° Elbow

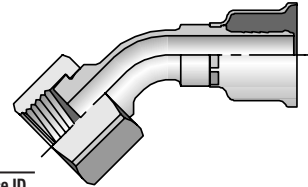

Part Number	Thread inch	Hose ID inch
1J726-4-4	1/4 9/16x18	3/16
1J726-6-6	3/8 1-1/16x16	5/16
1J726-8-8	1/2 13/16x16	13/32
1J726-10-10	5/8 1x14	1/2
1J726-12-12	3/4 1-3/16x12	5/8
1J726-16-16	1 1-7/16x12	7/8
1J726-20-20	1-1/4 1-11/16x12	1-1/8

### 1J926

Female Seal-Lok™ - Swivel - 90° Elbow - Short Drop

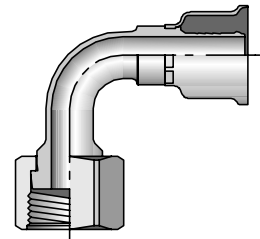

Part Number	Thread inch	Hose ID inch
1J926-4-4	1/4 9/16x18	3/16
1J926-6-6	3/8 1-1/16x16	5/16
1J926-8-8	1/2 13/16x16	13/32
1J926-10-10	5/8 1x14	1/2
1J926-12-12	3/4 1-3/16x12	5/8
1J926-16-16	1 1-7/16x12	7/8
1J926-20-20	1-1/4 1-11/16x12	1-1/8

26 Series: Use with 201, 206, 213, 221FR, 244, 266, 285, 293, SS23CG hoses.

Dimensions and pressures are for reference only and are subject to change.

## 1JC26

Female Seal-Lok™ - Swivel - Short

Part Number	Thread inch	Hose ID inch
1JC26-4-4	1/4 9/16x18	3/16
1JC26-6-6	3/8 11/16x16	5/16
1JC26-8-8	1/2 13/16x16	13/32
1JC26-12-12	3/4 1-3/16x12	5/8
1JC26-16-16	1 1-7/16x12	7/8
1JC26-20-20	1-1/4 1-11/16x12	1-1/8

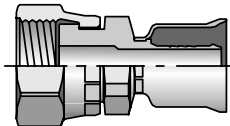

## 1S526-PR

Male Tube-O - Swivel - Short Pilot with Charge Port for R12

Part Number	Thread inch	Hose ID inch
1S526-10-10-PR	5/8 7/8x18	1/2
1S526-10-12-PR	5/8 7/8x18	5/8

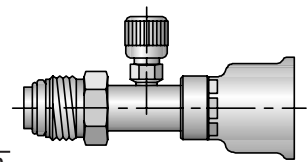

## 1RV26

Female Compressor - Swivel - 135° Elbow

Part Number	Hose ID inch
1RV26-12-8	13/32
1RV26-12-12	5/8

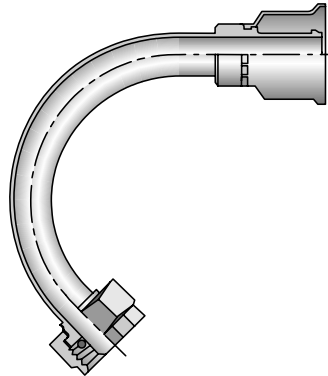

## 1T126

Male Refrigerant Tube Mender (with Nut and Ferrule)

Part Number	Thread inch	Hose ID inch
1T126-6-6	3/8 5/8x18	5/16
1T126-6-8	3/8 5/8x18	13/32
1T126-8-6	1/2 3/4x16	5/16
1T126-8-8	1/2 3/4x16	13/32
1T126-8-10	1/2 3/4x16	1/2
1T126-10-8	5/8 7/8x14	13/32
1T126-10-10	5/8 7/8x14	1/2
1T126-10-12	5/8 7/8x14	5/8
1T126-12-12	3/4 1-16x14	5/8

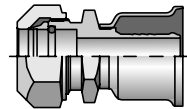

1T126 Assembly instructions are in [Section N](#).

## 1RZ26

Female Compressor - Swivel - 180° Elbow - Block Type RZ

Part Number	Hose ID inch
1RZ26-12-12	5/8

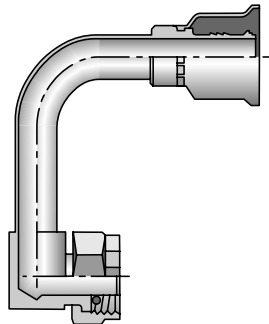

## 43 Series

### 10143

Male NPTF Pipe - Rigid

Part Number	Thread inch	Hose ID inch
10143-2-4	1/8x27	1/4
10143-4-4	1/4x18	1/4
10143-4-5	1/4x18	5/16
10143-4-6	1/4x18	3/8
10143-6-4	3/8x18	1/4
10143-6-5	3/8x18	5/16
10143-6-6	3/8x18	3/8
10143-6-8	3/8x18	1/2
10143-6-10	3/8x18	5/8
10143-8-4	1/2x14	1/4
10143-8-6	1/2x14	3/8
10143-8-8	1/2x14	1/2
10143-8-10	1/2x14	5/8
10143-8-12	1/2x14	3/4
10143-12-8	3/4x14	1/2
10143-12-10	3/4x14	5/8
10143-12-12	3/4x14	3/4
10143-12-16	3/4x14	1
10143-16-12	1x11-1/2	3/4
10143-16-16	1x11-1/2	1
10143-20-20	1-1/4x11-1/2	1-1/4
10143-24-24	1-1/2x11-1/2	1-1/2
10143-32-32	2x11-1/2	2

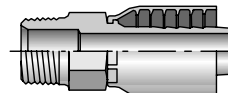

## 1S526

Male Tube-O - Swivel - Short Pilot

Part Number	Thread inch	Hose ID inch
1S526-6-6	3/8 5/8x18	5/16
1S526-7-6	11/16 11/16x16	5/16
1S526-8-8	1/2 3/4x18	13/32
1S526-10-10	5/8 7/8x18	1/2
1S526-10-12	5/8 7/8x18	5/8
1S526-12-12	3/4 1-1/16x16	5/8

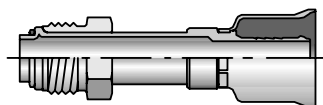

Stainless steel fittings must be assembled with [Karrykrimp 2](#), [PHastkrimp](#), [Superkrimp](#) or [Parkrimp 2](#).

See [www.parker.com/crimpsource](http://www.parker.com/crimpsource) for more information.

26 Series: Use with [201](#), [206](#), [213](#), [221FR](#), [244](#), [266](#), [285](#), [293](#), [SS23CG](#) hoses.

Dimensions and pressures are for reference only and are subject to change.

## 10243

Female NPTF Pipe - Rigid

Part Number	Thread inch	Hose ID inch
10243-2-4	1/8x27	1/4
10243-4-4	1/4x18	1/4
10243-4-6	1/4x18	3/8
10243-6-4	3/8x18	1/4
10243-6-6	3/8x18	3/8
10243-8-6	1/2x14	3/8
10243-8-8	1/2x14	1/2
10243-12-12	3/4x14	3/4

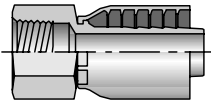

## 10343

Male JIC 37° - Rigid  
ISO 12151-5

Part Number	Thread inch	Hose ID inch	
10343-4-4	1/4	7/16x20	1/4
10343-5-4	5/16	1/2x20	1/4
10343-5-6	5/16	1/2x20	3/8
10343-6-4	3/8	9/16x18	1/4
10343-6-6	3/8	9/16x18	3/8
10343-8-6	1/2	3/4x16	3/8
10343-8-8	1/2	3/4x16	1/2
10343-8-10	1/2	3/4x16	5/8
10343-10-6	5/8	7/8x14	3/8
10343-10-8	5/8	7/8x14	1/2
10343-10-10	5/8	7/8x14	5/8
10343-12-8	3/4	1-1/16x12	1/2
10343-12-10	3/4	1-1/16x12	5/8
10343-12-12	3/4	1-1/16x12	3/4
10343-14-12	7/8	1-3/16x12	3/4
10343-16-12	1	1-5/16x12	3/4
10343-16-16	1	1-5/16x12	1
10343-20-20	1-1/4	1-5/8x12	1-1/4
10343-24-20	1-1/2	1-7/8x12	1-1/4

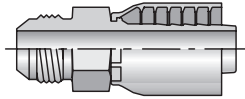

## 10443

Male SAE 45° - Rigid

Part Number	Thread inch	Hose ID inch	
10443-6-6	3/8	5/8x18	3/8
10443-12-12	3/4	1-1/16x14	3/4

Notch on nut signifies SAE 45° flare.

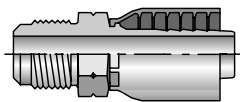

## 10543

Male SAE Straight Thread with O-Ring - Rigid

Part Number	Thread inch	Hose ID inch	
10543-4-4	1/4	7/16x20	1/4
10543-5-4	5/16	1/2x20	1/4
10543-6-4	3/8	9/16x18	1/4
10543-6-6	3/8	9/16x18	3/8
10543-6-8	3/8	9/16x18	1/2
10543-8-6	1/2	3/4x16	3/8
10543-8-8	1/2	3/4x16	1/2
10543-10-6	5/8	7/8x14	3/8
10543-10-8	5/8	7/8x14	1/2
10543-10-10	5/8	7/8x14	5/8
10543-12-8	3/4	1-1/16x12	1/2
10543-12-10	3/4	1-1/16x12	5/8
10543-12-12	3/4	1-1/16x12	3/4
10543-16-12	1	1-5/16x12	3/4
10543-16-16	1	1-5/16x12	1
10543-20-20	1-1/4	1-5/8x12	1-1/4

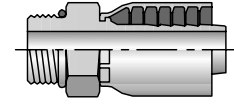

## 10643

Female JIC 37° - Swivel  
ISO 12151-5

Part Number	Thread inch	Hose ID inch	
10643-4-4	1/4	7/16x20	1/4
10643-4-6	1/4	7/16x20	3/8
10643-5-4	5/16	1/2x20	1/4
10643-5-5	5/16	1/2x20	5/16
10643-5-6	5/16	1/2x20	3/8
10643-6-4	3/8	9/16x18	1/4
10643-6-5	3/8	9/16x18	5/16
10643-6-6	3/8	9/16x18	3/8
10643-6-8	3/8	9/16x18	1/2
10643-8-6	1/2	3/4x16	3/8
10643-8-8	1/2	3/4x16	1/2
10643-8-10	1/2	3/4x16	5/8
10643-8-12	1/2	3/4x16	3/4
10643-10-6	5/8	7/8x14	3/8
10643-10-8	5/8	7/8x14	1/2
10643-10-10	5/8	7/8x14	5/8
10643-10-12	5/8	7/8x14	3/4
10643-12-8	3/4	1-1/16x12	1/2
10643-12-10	3/4	1-1/16x12	5/8
10643-12-12	3/4	1-1/16x12	3/4
10643-12-16	3/4	1-1/16x12	1
10643-14-12	7/8	1-3/16x12	3/4
10643-16-12	1	1-5/16x12	3/4
10643-16-16	1	1-5/16x12	1
10643-20-16	1-1/4	1-5/8x12	1
10643-20-20	1-1/4	1-5/8x12	1-1/4
10643-24-24	1-1/2	1-7/8x12	1-1/2
10643-32-32	2	2-1/2x12	2

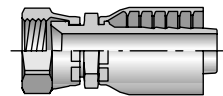

Stainless steel fittings must be assembled with [Karrykrimp 2](#), [PHastkrimp](#), [Superkrimp](#) or [Parkrimp 2](#).

See [www.parker.com/crimpsource](http://www.parker.com/crimpsource) for more information.

43 Series: Use with [301LT](#), [302](#), [304](#), [351ST](#), [351TC](#), [422](#), [424](#), [426](#), [431](#), [436](#), [451TC](#), [451ST](#), [471TC](#), [471ST](#), [472TC](#), [482TC](#), [482ST](#), [722TC](#), [881](#) hoses.

Dimensions and pressures are for reference only and are subject to change.

### 10743

Female NPSM Pipe - Swivel - (60° Cone)

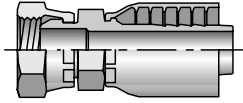

Part Number	Thread inch	Hose ID inch
10743-2-4	1/8x27	1/4
10743-4-4	1/4x18	1/4
10743-6-6	3/8x18	3/8
10743-8-8	1/2x14	1/2
10743-12-12	3/4x14	3/4
10743-16-16	1x11-1/2	1
10743-20-20	1-1/4x11-1/2	1-1/4

### 10843

Female SAE 45° - Swivel

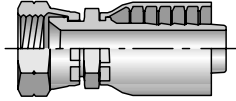

Part Number	Thread inch	Hose ID inch
10843-6-4	3/8 5/8x18	1/4
10843-6-6	3/8 5/8x18	3/8
10843-12-12	3/4 1-1/16x14	3/4

Notch on nut signifies SAE 45° flare.

### 10C43

Female Metric S - Swivel - 45° Elbow - (24° Cone with O-Ring) ISO 12151-2 - SWE45

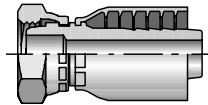

Part Number	Thread mm	Hose ID inch
10C43-8-4	8 M16x1,5	1/4
10C43-12-5	12 M20x1,5	5/16
10C43-12-6	12 M20x1,5	3/8
10C43-16-8	16 M24x1,5	1/2
10C43-20-10	20 M30x2	5/8
10C43-20-12	20 M30x2	3/4
10C43-25-12	25 M36x2	3/4
10C43-30-16	30 M42x2	1
10C43-38-20^^	38 M52x2	1-1/4

^^Must be assembled with Die Part No. 83C-A20H in a Superkrimp or Parkrimp 2.

Metric S: Mates with EO "S" Series Fittings.

### 10G43

Male SAE Straight Thread with O-Ring - Swivel

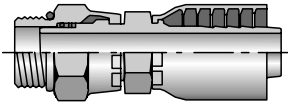

Part Number	Thread inch	Hose ID inch
10G43-5-4	5/16 1/2x20	1/4
10G43-6-4	3/8 9/16x18	1/4
10G43-6-6	3/8 9/16x18	3/8
10G43-8-6	1/2 3/4x16	3/8
10G43-8-8	1/2 3/4x16	1/2
10G43-10-6	5/8 7/8x14	3/8
10G43-10-8	5/8 7/8x14	1/2
10G43-12-12	3/4 1-1/16x12	3/4

O-Ring not compatible with Phosphate Ester fluids.

Fitting allows minor movement under pressure to relieve stress on hose but is not to be used on continuous or extensive swiveling.

### 10L43

Male SAE Straight Thread with O-Ring - Swivel - 90° Elbow

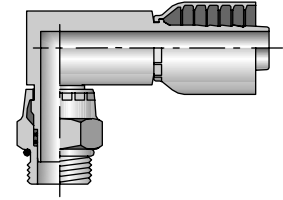

Part Number	Thread inch	Hose ID inch
10L43-6-6	3/8 9/16x18	3/8
10L43-8-6	1/2 3/4x16	3/8
10L43-8-8	1/2 3/4x16	1/2
10L43-10-8	5/8 7/8x14	1/2
10L43-12-12	3/4 1-1/16x12	3/4

O-Ring not compatible with Phosphate Ester fluids.

See Section O for pressure limitations.

Fitting allows minor movement under pressure to relieve stress on hose but is not to be used on continuous or extensive swiveling.

### 11143

Male Ferulok Flareless - Rigid (24° Cone with Nut and Ferrule)

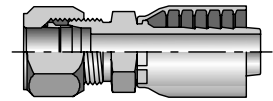

Part Number	Thread inch	Hose ID inch
11143-4-4	1/4 7/16x20	1/4
11143-4-6	1/4 7/16x20	3/8
11143-5-4	5/16 1/2x20	1/4
11143-5-6	5/16 1/2x20	3/8
11143-6-6	3/8 9/16x18	3/8
11143-8-8	1/2 3/4x16	1/2
11143-10-8	5/8 7/8x14	1/2
11143-12-12	3/4 1-1/16x12	3/4
11143-16-16	1 1-5/16x12	1

The Parker Ferrul-Fix fitting makes it possible to salvage the bent tube section from a hose assembly for quick, easy on-the-job repairs. For additional information see Ferrule-Fix installation instructions in Section N.

Notch on nut signifies SAE 45° flare.

### 11243

Female Ferulok Flareless - Swivel - (24° Cone)

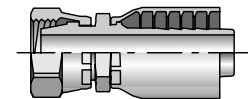

Part Number	Thread inch	Hose ID inch
11243-6-6	3/8 9/16x18	3/8
11243-8-6	1/2 3/4x16	3/8
11243-8-8	1/2 3/4x16	1/2

43 Series: Use with 301LT, 302, 304, 351ST, 351TC, 422, 424, 426, 431, 436, 451TC, 451ST, 471TC, 471ST, 472TC, 482TC, 482ST, 722TC, 881 hoses.

Dimensions and pressures are for reference only and are subject to change.

### 11343

Male NPTF Pipe - Swivel

Part Number	Thread inch	Hose ID inch
11343-2-4	1/8x27	1/4
11343-4-4	1/4x18	1/4
11343-4-6	1/4x18	3/8
11343-6-4	3/8x18	1/4
11343-6-6	3/8x18	3/8
11343-6-8	3/8x18	1/2
11343-8-6	1/2x14	3/8
11343-8-8	1/2x14	1/2
11343-12-12	3/4x14	3/4
11343-16-16	1x11-1/2	1

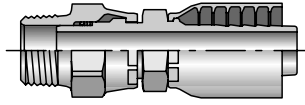

O-Ring not compatible with Phosphate Ester fluids.

Fitting allows minor movement under pressure to relieve stress on hose but is not to be used on continuous or extensive swiveling.

### 11543

SAE Code 61 Flange Head  
ISO 12151-3 - S - L

Part Number	Flange inch	Hose ID inch
11543-8-8	1/2	1/2
11543-10-10	5/8	5/8
11543-12-8	3/4	1/2
11543-12-12	3/4	3/4
11543-16-12	1	3/4
11543-16-16	1	1
11543-20-16	1-1/4	1
11543-20-20	1-1/4	1-1/4
11543-24-20	1-1/2	1-1/4
11543-24-24	1-1/2	1-1/2
11543-24-32	1-1/2	2
11543-32-20	2	1-1/4
11543-32-24	2	1-1/2
11543-32-32	2	2

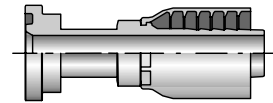

### 11643

SAE Code 61 Flange Head - 22-1/2° Elbow  
ISO 12151-3 - E22M - L

Part Number	Flange inch	Hose ID inch
11643-12-12	3/4	3/4
11643-16-12	1	3/4
11643-16-16	1	1
11643-20-16	1-1/4	1
11643-20-20	1-1/4	1-1/4
11643-24-20	1-1/2	1-1/4

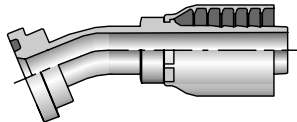

### 11743

SAE Code 61 Flange Head - 45° Elbow  
ISO 12151-3 - E45S - L  
(1 Piece: ISO 12151-3 - E45M - L)

Part Number	Flange inch	Hose ID inch
11743-8-8	1/2	1/2
11743-10-10	5/8	5/8
11743-12-8	3/4	1/2
11743-12-12	3/4	3/4
11743-16-12	1	3/4
11743-16-16	1	1
11743-20-16	1-1/4	1
11743-20-20	1-1/4	1-1/4
11743-20-24	1-1/4	1-1/2
11743-24-20	1-1/2	1-1/4
11743-24-24	1-1/2	1-1/2
11743-32-24	2	1-1/2
11743-32-32	2	2

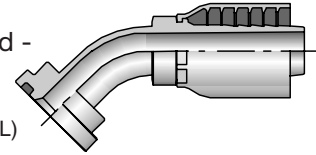

### 11843

SAE Code 61 Flange Head - 67-1/2° Elbow  
ISO 12151-3 - E67S - L  
(1 Piece: ISO 12151-3 - E67M - L)

Part Number	Flange inch	Hose ID inch
11843-12-12	3/4	3/4
11843-16-16	1	1
11843-20-20	1-1/4	1-1/4

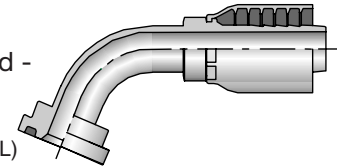

### 11943

SAE Code 61 Flange Head - 90° Elbow  
ISO 12151-3 - E90S - L  
(1 Piece: ISO 12151-3 - E90M - L)

Part Number	Flange inch	Hose ID inch
11943-8-8	1/2	1/2
11943-10-10	5/8	5/8
11943-12-8	3/4	1/2
11943-12-10	3/4	5/8
11943-12-12	3/4	3/4
11943-16-8	1	1/2
11943-16-12	1	3/4
11943-16-16	1	1
11943-20-16	1-1/4	1
11943-20-20	1-1/4	1-1/4
11943-24-20	1-1/2	1-1/4
11943-20-24	1-1/4	1-1/2
11943-24-24	1-1/2	1-1/2
11943-32-24	2	1-1/2
11943-32-32	2	2

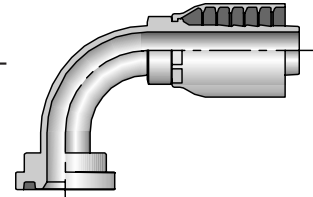

43 Series: Use with 301LT, 302, 304, 351ST, 351TC, 422, 424, 426, 431, 436, 451TC, 451ST, 471TC, 471ST, 472TC, 482TC, 482ST, 722TC, 881 hoses.

Dimensions and pressures are for reference only and are subject to change.

### 11C43

Female Metric S - Swivel - 90° Elbow - (24° Cone with O-Ring)  
ISO 12151-2 - SWE

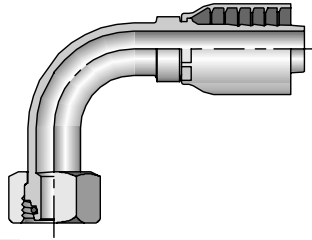

Part Number	Thread mm	Hose ID inch
11C43-8-4	M16x1,5	1/4
11C43-10-4	M18x1,5	1/4
11C43-12-5	M20x1,5	5/16
11C43-12-6	M20x1,5	3/8
11C43-14-6	M22x1,5	3/8
11C43-16-8	M24x1,5	1/2
11C43-20-10	M30x2	5/8
11C43-25-12	M36x2	3/4
11C43-30-16	M42x2	1
11C43-38-20^^	M52x2	1-1/4

^^Must be assembled with Die Part No. 83C-A20H in a Superkrimp or Parkrimp 2.

Metric S: Mates with EO "S" Series Fittings.

### 11D43

Male Standpipe Metric L - Rigid End Connection per ISO 8434-1-SDS

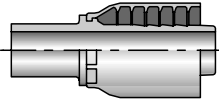

Part Number	Hose ID inch
11D43-6-4	1/4
11D43-10-5	5/16
11D43-10-6	3/8
11D43-12-4	1/4
11D43-15-8	1/2
11D43-18-10	5/8
11D43-18-12	3/4
11D43-22-12	3/4
11D43-28-16	1

Metric L: Mates with EO "L" Series Fittings.

### 11L43

Male NPTF Pipe - Swivel - 90° Elbow

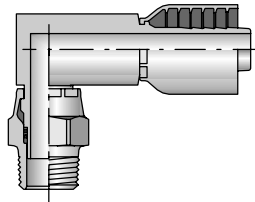

Part Number	Thread inch	Hose ID inch
11L43-4-4	1/4x18	1/4
11L43-4-6	1/4x18	3/8
11L43-6-6	3/8x18	3/8
11L43-8-6	1/2x14	3/8
11L43-8-8	1/2x14	1/2
11L43-12-12	3/4x14	3/4

O-Ring not compatible with Phosphate Ester fluids.  
Fitting allows minor movement under pressure to relieve stress on hose but is not to be used on continuous or extensive swiveling.

### 12643

SAE Code 61 Flange Head - 30° Elbow  
ISO 12151-3 - E30S - L  
(1 Piece: ISO 12151-3 - E30M - L)

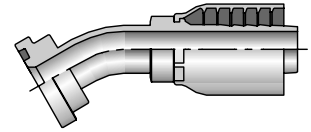

Part Number	Flange inch	Hose ID inch
12643-12-12	3/4	3/4
12643-16-16	1	1
12643-20-16	1-1/4	1
12643-20-20	1-1/4	1-1/4

### 12743

SAE Code 61 Flange Head - 60° Elbow  
ISO 12151-3 - E60S - L  
(1 Piece: ISO 12151-3 - E60M - L)

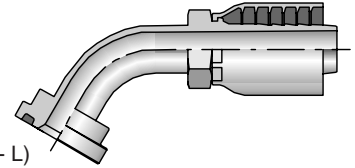

Part Number	Flange inch	Hose ID inch
12743-12-12	3/4	3/4
12743-16-12	1	3/4
12743-16-16	1	1
12743-20-20	1-1/4	1-1/4

### 12843

Male Inverted SAE 45° - Swivel

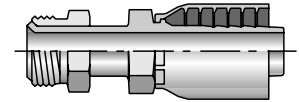

Part Number	Thread inch	Hose ID inch
12843-4-4	1/4 7/16x24	1/4
12843-4-6	1/4 7/16x24	3/8
12843-5-4	5/16 1/2x20	1/4
12843-5-6	5/16 1/2x20	3/8
12843-6-6	3/8 5/8x18	3/8
12843-7-6	7/16 11/16x18	3/8
12843-8-8	1/2 3/4x18	1/2
12843-10-10	5/8 7/8x18	5/8

### 13743

Female JIC 37° - Swivel - 45° Elbow - Short Drop  
ISO 12151-5

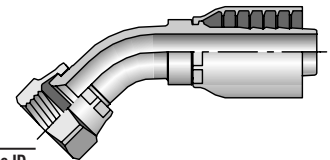

Part Number	Thread inch	Hose ID inch
13743-4-4	1/4 7/16x20	1/4
13743-5-4	5/16 1/2x20	1/4
13743-6-4	3/8 9/16x18	1/4
13743-6-6	3/8 9/16x18	3/8
13743-8-6	1/2 3/4x16	3/8
13743-8-8	1/2 3/4x16	1/2
13743-10-8	5/8 7/8x14	1/2
13743-10-10	5/8 7/8x14	5/8
13743-12-10	3/4 1-1/16x12	5/8
13743-12-12	3/4 1-1/16x12	3/4
13743-16-16	1 1-5/16x12	1
13743-20-20	1-1/4 1-5/8x12	1-1/4
13743-24-24	1-1/2 1-7/8x12	1-1/2

43 Series: Use with 301LT, 302, 304, 351ST, 351TC, 422, 424, 426, 431, 436, 451TC, 451ST, 471TC, 471ST, 472TC, 482TC, 482ST, 722TC, 881 hoses.

Dimensions and pressures are for reference only and are subject to change.

### 13943

Female JIC 37° - Swivel - 90° Elbow - Short Drop  
ISO 12151-5

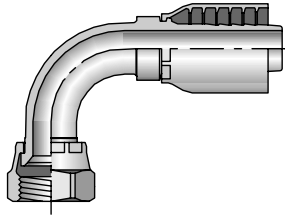

Part Number	Thread inch	Hose ID inch
13943-4-4	1/4	7/16x20
13943-4-6	1/4	7/16x20
13943-5-4	5/16	1/2x20
13943-5-5	5/16	1/2x20
13943-6-4	3/8	9/16x18
13943-6-6	3/8	9/16x18
13943-6-8	3/8	9/16x18
13943-8-6	1/2	3/4x16
13943-8-8	1/2	3/4x16
13943-10-8	5/8	7/8x14
13943-10-10	5/8	7/8x14
13943-12-8	3/4	1-1/16x12
13943-12-10	3/4	1-1/16x12
13943-12-12	3/4	1-1/16x12
13943-16-12	1	1-5/16x12
13943-16-16	1	1-5/16x12
13943-20-20	1-1/4	1-5/8x12
13943-24-24	1-1/2	1-7/8x12
13943-32-32	2	2-1/2x12

### 13D43

Male Standpipe Metric S - Rigid  
End Connection per ISO 8434-1-SDS

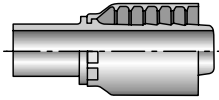

Part Number	Hose ID inch
13D43-10-4	1/4
13D43-12-5	5/16
13D43-14-6	3/8
13D43-16-8	1/2
13D43-20-10	5/8
13D43-20-12	3/4
13D43-25-12	3/4
13D43-30-16	1

Light Series 11D43-6-4, 11D43-8-4 and 11D43-12-6 are used in place of their Heavy Series equivalent size and accept the EO Heavy "S" Series ferrules and nuts.

Metric S: Mates with EO "S" Series Fittings.

### 14143

Female JIC 37° - Swivel - 90° Elbow - Long Drop  
ISO 12151-5

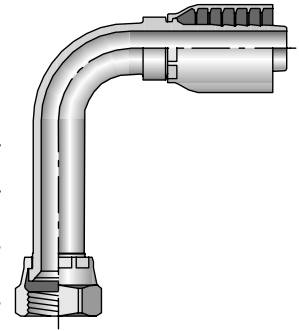

Part Number	Thread inch	Hose ID inch
14143-4-4	1/4	7/16x20
14143-5-4	5/16	1/2x20
14143-6-6	3/8	9/16x18
14143-8-6	1/2	3/4x16
14143-8-8	1/2	3/4x16
14143-10-8	5/8	7/8x14
14143-10-10	5/8	7/8x14
14143-12-12	3/4	1-1/16x12
14143-14-12	7/8	1-3/16x12
14143-16-16	1	1-5/16x12
14143-20-20	1-1/4	1-5/8x12

Notch on nut signifies SAE 45° flare.

### 14943

DIN Metric Banjo

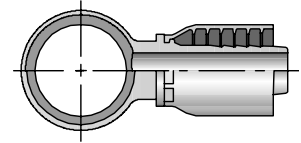

Part Number	R mm	Hose ID inch
14943-10-4	10	1/4
14943-12-4	12	1/4
14943-14-5	14	5/16
14943-16-6	16	3/8
14943-18-8	18	1/2
14943-22-10	22	5/8
14943-26-12	26	3/4

### AM

Banjo Bolt with DIN Metric Thread

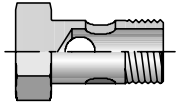

Part Number	R Thread mm
AM-03	8 M8x1
AM-04	10 M10x1
AM-06	12 M12x1.5
AM-08	14 M14x1.5
AM-10	16 M16x1.5
AM-13	18 M18x1.5
AM-16	22 M22x1.5
AM-20	26 M26x1.5
AM-30	30 M30x1.5

Two (2) copper washers per bolt must be ordered separately.

### 14V43

Female JIC 37° - Swivel - 150° Elbow  
ISO 12151-5

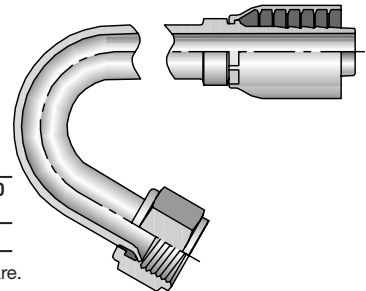

Part Number	Thread inch	Hose ID inch
14V43-6-4	3/8	9/16x18

Notch on nut signifies SAE 45° flare.

43 Series: Use with 301LT, 302, 304, 351ST, 351TC, 422, 424, 426, 431, 436, 451TC, 451ST, 471TC, 471ST, 472TC, 482TC, 482ST, 722TC, 881 hoses.

Dimensions and pressures are for reference only and are subject to change.



### 16743

Male Inverted SAE 45° - Swivel - 45° Elbow

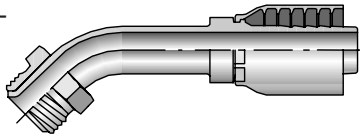

Part Number	Thread inch	Hose ID inch
16743-4-4	1/4	7/16x24
16743-4-6	1/4	7/16x24
16743-5-4	5/16	1/2x20
16743-5-6	5/16	1/2x20
16743-6-6	3/8	5/8x18
16743-8-8	1/2	3/4x18

### 16943

Male Inverted SAE 45° - Swivel - 90° Elbow

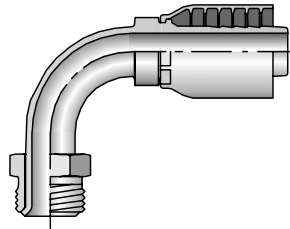

Part Number	Thread inch	Hose ID inch
16943-4-4	1/4	7/16x24
16943-4-6	1/4	7/16x24
16943-5-4	5/16	1/2x20
16943-5-6	5/16	1/2x20
16943-6-6	3/8	5/8x18
16943-7-6	7/16	11/16x18
16943-8-8	1/2	3/4x18

### 16A43

SAE Code 62 Flange Head ISO 12151-3 - S - S

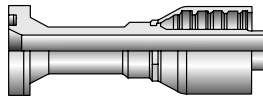

Part Number	Flange inch	Hose ID inch
16A43-12-12	3/4	3/4
16A43-16-12	1	3/4
16A43-16-16	1	1
16A43-20-16	1-1/4	1
16A43-20-20	1-1/4	1-1/4

### 16F43

SAE Code 62 Flange Head - 45° Elbow  
ISO 12151-3 - E45S - S  
(1 Piece 12151-3-E45M-S)

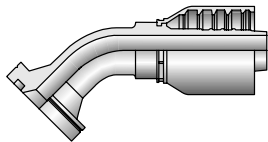

Part Number	Flange inch	Hose ID inch
16F43-12-12	3/4	3/4
16F43-16-16	1	1
16F43-20-16	1-1/4	1

### 16N43

SAE Code 62 Flange Head - 90° Elbow  
ISO 12151-3 - E90S - S  
(1 Piece 12151-3-E90M-S)

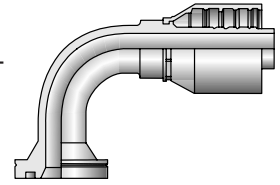

Part Number	Flange inch	Hose ID inch
16N43-12-12	3/4	3/4
16N43-16-12	1	3/4
16N43-16-16	1	1
16N43-20-16	1-1/4	1
16N43-20-20	1-1/4	1-1/4

### 17743

Female SAE 45° - Swivel - 45° Elbow

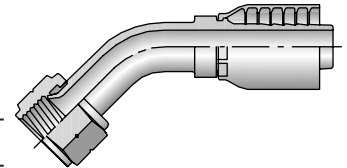

Part Number	Thread inch	Hose ID inch
17743-4-6	1/4	7/16x20

Notch on nut signifies SAE 45° flare.

### 17943

Female SAE 45° - Swivel - 90° Elbow

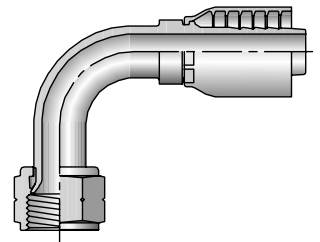

Part Number	Thread inch	Hose ID inch
17943-6-6	3/8	5/8x18

Notch on nut signifies SAE 45° flare.

### 19243

Female BSP Parallel Pipe - Swivel - (60° Cone)  
ISO 12151-6

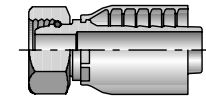

Part Number	Thread inch	Hose ID inch
19243-2-4	1/8x28	1/4
19243-4-4	1/4x19	1/4
19243-6-4	3/8x19	1/4
19243-6-6	3/8x19	3/8
19243-6-8	3/8x19	1/2
19243-8-6	1/2x14	3/8
19243-8-8	1/2x14	1/2
19243-10-8	5/8x14	1/2
19243-10-10	5/8x14	5/8
19243-12-10	3/4x14	5/8
19243-12-12	3/4x14	3/4
19243-16-16	1x11	1
19243-20-20	1-1/4x11	1-1/4

43 Series: Use with 301LT, 302, 304, 351ST, 351TC, 422, 424, 426, 431, 436, 451TC, 451ST, 471TC, 471ST, 472TC, 482TC, 482ST, 722TC, 881 hoses.

Dimensions and pressures are for reference only and are subject to change.

### 1B143

Female BSP Parallel Pipe -  
Swivel - 45° Elbow -  
(60° Cone)  
ISO 12151-6

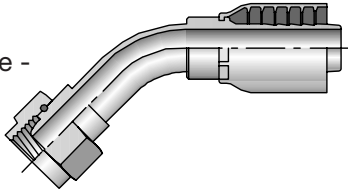

Part Number	Thread inch	Hose ID inch
1B143-4-4	1/4x19	1/4
1B143-6-6	3/8x19	3/8
1B143-8-8	1/2x14	1/2
1B143-10-10	5/8x14	5/8
1B143-12-10	3/4x14	5/8
1B143-12-12	3/4x14	3/4
1B143-16-16	1x11	1

### 1B243

Female BSP Parallel Pipe -  
Swivel - 90° Elbow -  
(60° Cone)  
ISO 12151-6

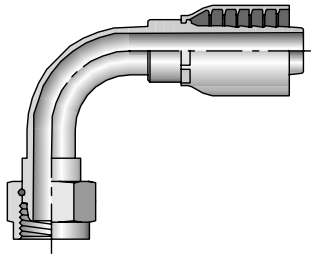

Part Number	Thread inch	Hose ID inch
1B243-2-4	1/8x28	1/4
1B243-4-4	1/4x19	1/4
1B243-6-6	3/8x19	3/8
1B243-8-6	1/2x14	3/8
1B243-8-8	1/2x14	1/2
1B243-10-8	5/8x14	1/2
1B243-10-10	5/8x14	5/8
1B243-12-10	3/4x14	5/8
1B243-12-12	3/4x14	3/4
1B243-16-16	1x11	1
1B243-20-20	1-1/4x11	1-1/4

### 1B443

Female BSP Parallel Pipe -  
Swivel - 90° Elbow -  
Block Type - (60° Cone)  
ISO 228-1

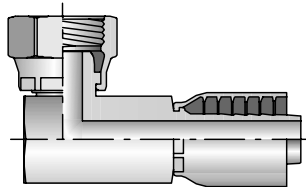

Part Number	Thread inch	Hose ID inch
1B443-4-4	1/4x19	1/4
1B443-6-6	3/8x19	3/8
1B443-8-8	1/2x14	1/2
1B443-12-12	3/4x14	3/4

### 1B543

Female BSP Parallel Pipe -  
Swivel - (Flat Seat)  
ISO 228-1

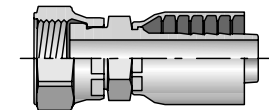

Part Number	Thread inch	Hose ID inch
1B543-6-6	3/8x19	3/8
1B543-8-6	1/2x14	3/8
1B543-8-8	1/2x14	1/2
1B543-12-12	3/4x14	3/4

### 1C043

Female Metric - Swivel -  
(Ball Nose)

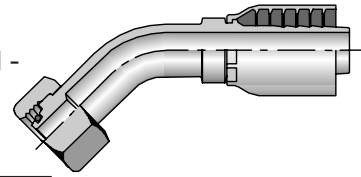

Part Number	Thread mm	Hose ID inch
1C043-20-12	20 M30x1,5	3/4
1C043-25-16	25 M38x1,5	1

### 1C343

Female Metric L - Swivel -  
(Ball Nose)

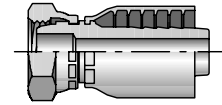

Part Number	Thread mm	Hose ID inch
1C343-6-4	6 M12x1,5	1/4
1C343-8-4	8 M14x1,5	1/4
1C343-10-5	10 M16x1,5	5/16
1C343-10-6	10 M16x1,5	3/8
1C343-12-5	12 M18x1,5	5/16
1C343-12-6	12 M18x1,5	3/8
1C343-15-6	6 M22x1,5	3/8
1C343-15-8	15 M22x1,5	1/2
1C343-18-10	18 M26x1,5	5/8
1C343-18-12	18 M26x1,5	3/4
1C343-22-12	22 M30x2	3/4
1C343-28-16	28 M36x2	1

Metric L: Mates with EO "L" Series Fittings.

### 1C443

Female Metric L - Swivel -  
45° Elbow - (Ball Nose)

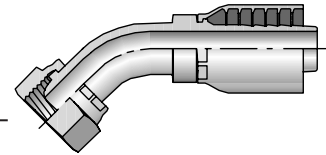

Part Number	Thread mm	Hose ID inch
1C443-8-4	8 M14x1,5	1/4
1C443-10-5	10 M16x1,5	5/16
1C443-10-6	10 M16x1,5	3/8
1C443-12-6	12 M18x1,5	3/8
1C443-15-8	15 M22x1,5	1/2
1C443-18-10	18 M26x1,5	5/8
1C443-22-12	22 M30x2	3/4
1C443-28-16	28 M36x2	1

Metric L: Mates with EO "L" Series Fittings.

### 1C543

Female Metric L - Swivel -  
90° Elbow - (Ball Nose)

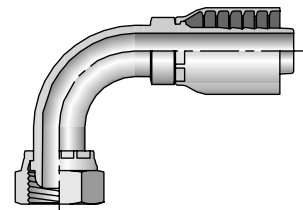

Part Number	Thread mm	Hose ID inch
1C543-8-4	8 M14x1,5	1/4
1C543-10-5	10 M16x1,5	5/16
1C543-10-6	10 M16x1,5	3/8
1C543-12-6	12 M18x1,5	3/8
1C543-15-8	15 M22x1,5	1/2
1C543-18-10	18 M26x1,5	5/8
1C543-22-12	22 M30x2	3/4
1C543-28-16	28 M36x2	1

Metric L: Mates with EO "L" Series Fittings.

43 Series: Use with 301LT, 302, 304, 351ST, 351TC, 422, 424, 426, 431, 436, 451TC, 451ST, 471TC, 471ST, 472TC, 482TC, 482ST, 722TC, 881 hoses.

Dimensions and pressures are for reference only and are subject to change.

### 1C643

Female Metric S - Swivel - (Ball Nose)

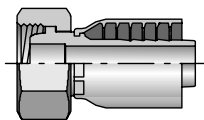

Part Number	Thread mm	Hose ID inch
1C643-8-4	8 M16x1,5	1/4
1C643-10-4	10 M18x1,5	1/4
1C643-12-5	12 M20x1,5	5/16
1C643-12-6	12 M20x1,5	3/8
1C643-12-8	12 M20x1,5	1/2
1C643-14-6	14 M22x1,5	3/8
1C643-16-8	16 M24x1,5	1/2
1C643-20-10	20 M30x2	5/8
1C643-20-12	20 M30x2	3/4
1C643-25-12	25 M36x2	3/4
1C643-30-16	30 M42x2	1

Metric S: Mates with EO "S" Series Fittings.

### 1C943

Female Metric S - Swivel - (24° Cone with O-Ring)  
ISO 12151-2 - SWS

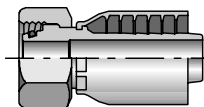

Part Number	Thread mm	Hose ID inch
1C943-6-4	6 M14x1,5	1/4
1C943-8-4	8 M16x1,5	1/4
1C943-10-4	10 M18x1,5	1/4
1C943-10-5	10 M18x1,5	5/16
1C943-10-6	10 M18x1,5	3/8
1C943-12-5	12 M20x1,5	5/16
1C943-12-6	12 M20x1,5	3/8
1C943-14-6	14 M22x1,5	3/8
1C943-16-8	16 M24x1,5	1/2
1C943-20-10	20 M30x2	5/8
1C943-20-12	20 M30x2	3/4
1C943-25-12	25 M36x2	3/4
1C943-25-16	25 M36x2	1
1C943-30-16	30 M42x2	1
1C943-38-20	38 M52x2	1-1/4

Metric S: Mates with EO "S" Series Fittings.

### 1CA43

Female Metric L - Swivel - (24° Cone with O-Ring)  
ISO 12151-2 - SWS

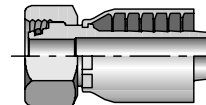

Part Number	Thread mm	Hose ID inch
1CA43-6-4	6 M12x1,5	1/4
1CA43-8-4	8 M14x1,5	1/4
1CA43-8-5	8 M14x1,5	5/16
1CA43-10-4	10 M16x1,5	1/4
1CA43-10-5	10 M16x1,5	5/16
1CA43-12-5	12 M18x1,5	5/16
1CA43-12-6	12 M18x1,5	3/8
1CA43-15-8	15 M22x1,5	1/2
1CA43-18-10	18 M26x1,5	5/8
1CA43-18-12	18 M26x1,5	3/4
1CA43-22-12	22 M30x2	3/4
1CA43-28-16	28 M36x2	1
1CA43-35-20	35 M45x2	1-1/4

Metric L: Mates with EO "L" Series Fittings.

### 1CE43

Female Metric L - Swivel - 45° Elbow - (24° Cone with O-Ring)  
ISO 12151-2 - SWE45

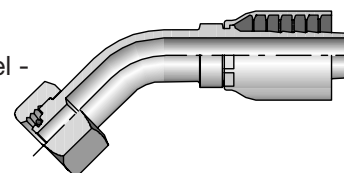

Part Number	Thread mm	Hose ID inch
1CE43-6-4	6 M12x1,5	1/4
1CE43-8-4	8 M14x1,5	1/4
1CE43-10-5	10 M16x1,5	5/16
1CE43-10-6	10 M16x1,5	3/8
1CE43-12-6	12 M18x1,5	3/8
1CE43-15-8	15 M22x1,5	1/2
1CE43-18-10	18 M26x1,5	5/8
1CE43-22-12	22 M30x2	3/4

Metric L: Mates with EO "L" Series Fittings.

### 1CF43

Female Metric L - Swivel - 90° Elbow - (24° Cone with O-Ring)  
ISO 12151-2 - SWE

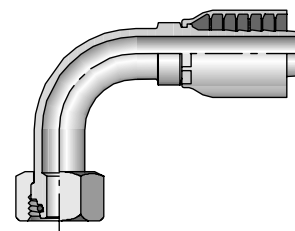

Part Number	Thread mm	Hose ID inch
1CF43-8-4	8 M14x1,5	1/4
1CF43-10-4	10 M16x1,5	1/4
1CF43-10-5	10 M16x1,5	5/16
1CF43-10-6	10 M16x1,5	3/8
1CF43-12-5	12 M18x1,5	5/16
1CF43-12-6	12 M18x1,5	3/8
1CF43-15-8	15 M22x1,5	1/2
1CF43-18-10	18 M26x1,5	5/8
1CF43-22-12	22 M30x2	3/4
1CF43-35-20	35 M45x2	1-1/4

Metric L: Mates with EO "L" Series Fittings.

43 Series: Use with 301LT, 302, 304, 351ST, 351TC, 422, 424, 426, 431, 436, 451TC, 451ST, 471TC, 471ST, 472TC, 482TC, 482ST, 722TC, 881 hoses.

Dimensions and pressures are for reference only and are subject to change.

### 1D043

Male Metric L - Rigid - (24° Cone)  
ISO 12151-2

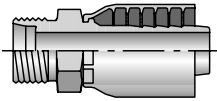

Part Number	Thread mm	Hose ID inch
1D043-6-4	6 M12x1,5	1/4
1D043-8-4	8 M14x1,5	1/4
1D043-10-5	10 M16x1,5	5/16
1D043-10-6	10 M16x1,5	3/8
1D043-12-5	12 M18x1,5	5/16
1D043-12-6	12 M18x1,5	3/8
1D043-15-6	15 M22x1,5	3/8
1D043-15-8	15 M22x1,5	1/2
1D043-18-10	18 M26x1,5	5/8
1D043-18-12	18 M26x1,5	3/4
1D043-22-12	22 M30x2	3/4
1D043-28-16	28 M36x2	1
1D043-35-20	35 M45x2	1-1/4

### 1D243

Male Metric S - Rigid - (24° Cone)  
ISO 12151-2

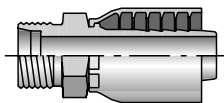

Part Number	Thread mm	Hose ID inch
1D243-8-4	8 M16x1,5	1/4
1D243-10-4	10 M18x1,5	1/4
1D243-12-5	12 M20x1,5	5/16
1D243-12-6	12 M20x1,5	3/8
1D243-14-6	14 M22x1,5	3/8
1D243-16-8	16 M24x1,5	1/2
1D243-20-10	20 M30x2	5/8
1D243-25-12	25 M36x2	3/4
1D243-30-16	30 M42x2	1

Metric S: Mates with EO "S" Series Fittings.

### 1D943

Male BSP Parallel Pipe - Rigid - (60° Cone)  
ISO 12151-6

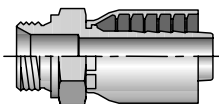

Part Number	Thread inch	Hose ID inch
1D943-4-4	1/4x19	1/4
1D943-6-5	3/8x19	5/16
1D943-6-6	3/8x19	3/8
1D943-8-6	1/2x14	3/8
1D943-8-8	1/2x14	1/2
1D943-12-12	3/4x14	3/4
1D943-16-16	1x11	1

When used in a port, a bonded seal must be used.

### 1EN43

UPTC Male

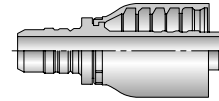

Part Number	Hose End Size inch
1EN43-8-4	1/4
1EN43-12-6	3/8
1EN43-15-8	1/2
1EN43-18-10	5/8
1EN43-22-12	3/4

### 1ET43

UPTC Male 90° Elbow

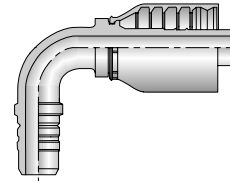

Part Number	Hose End Size inch
1ET43-8-4	1/4
1ET43-12-6	3/8
1ET43-15-8	1/2
1ET43-18-10	5/8
1ET43-22-12	3/4

### 1EU43

UPTC Male 45° Elbow

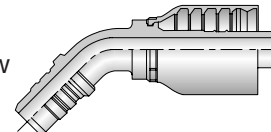

Part Number	Hose End Size inch
1EU43-8-4	1/4
1EU43-12-6	3/8
1EU43-15-8	1/2
1EU43-18-10	5/8
1EU43-22-12	3/4

### 1F443

Female French Gaz Series - Swivel - (Ball Nose)

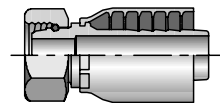

Part Number	Thread mm	Hose ID inch
1F443-27-12	27 M36x1,5	3/4

### 1FU43

Female BSP Parallel Pipe - Swivel - (30° Flare)  
B8363 Code F

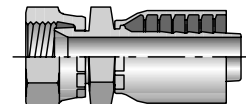

Part Number	Thread inch	Hose ID inch
1FU43-4-4	1/4x19	1/4
1FU43-6-6	3/8x19	3/8
1FU43-8-8	1/2x14	1/2
1FU43-12-12	3/4x14	3/4
1FU43-16-16	1x11	1
1FU43-20-20	1-1/4x11	1-1/4

43 Series: Use with 301LT, 302, 304, 351ST, 351TC, 422, 424, 426, 431, 436, 451TC, 451ST, 471TC, 471ST, 472TC, 482TC, 482ST, 722TC, 881 hoses.

Dimensions and pressures are for reference only and are subject to change.

### 1GJ43

Female Grease Connection - SPL - PTF Taper Thread  
Rigid - 1/2 x 27

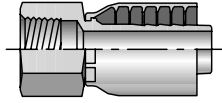

Part Number	Thread inch	Hose ID inch
1GJ43-4-4	1/2x27	1/4
1GJ43-4-6	1/2x27	3/8

### 1GU43

Female BSP Parallel Pipe - Swivel - (60° Cone)  
B8363 Code C

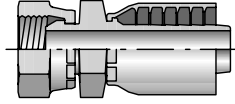

Part Number	Thread inch	Hose ID inch
1GU43-4-4	1/4x19	1/4
1GU43-6-6	3/8x19	3/8
1GU43-8-8	1/2x14	1/2
1GU43-12-12	3/4x14	3/4
1GU43-16-16	1x11	1
1GU43-20-20	1-1/4x11	1-1/4

### 1J043

Male Seal-Lok™ - Rigid - (with O-Ring)  
ISO 12151-1 - S

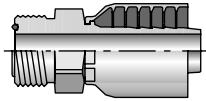

Part Number	Thread inch	Hose ID inch
1J043-4-4	1/4	9/16x18
1J043-6-6	3/8	11/16x16
1J043-8-6	1/2	13/16x16
1J043-8-8	1/2	13/16x16
1J043-10-8	5/8	1x14
1J043-10-10	5/8	1x14
1J043-12-10	3/4	1-3/16x12
1J043-12-12	3/4	1-3/16x12
1J043-16-12	1	1-7/16x12
1J043-16-16	1	1-7/16x12
1J043-20-20	1-1/4	1-11/16x12

Fittings are stocked less locknut ([part no. WLNL](#)). Locknuts are manufactured by the Parker Tube Fittings Division and must be ordered separately.

### 1J143

Female Seal-Lok™ - Swivel - 90° Elbow - Long Drop  
ISO 12151-1 - SWEL90

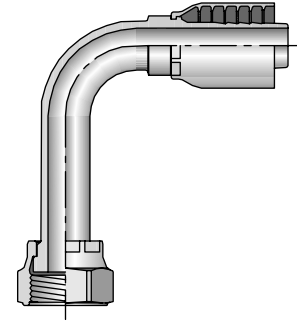

Part Number	Thread inch	Hose ID inch
1J143-4-4	1/4	9/16x18
1J143-6-4	3/8	11/16x16
1J143-6-6	3/8	11/16x16
1J143-8-6	1/2	13/16x16
1J143-8-8	1/2	13/16x16
1J143-8-8-SM	1/2	13/16x16
1J143-10-8	5/8	1x14
1J143-10-10	5/8	1x14
1J143-10-12	5/8	1x14
1J143-12-12	3/4	1-3/16x12
1J143-16-16	1	1-7/16x12
1J143-20-20	1-1/4	1-11/16x12
1J143-24-20	1-1/2	2x12

### 1J543

Female Seal-Lok™ - Swivel - 90° Elbow - Medium Drop  
ISO 12151-1 - SWEM90

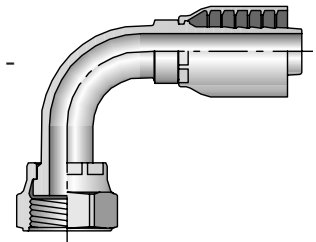

Part Number	Thread inch	Hose ID inch
1J543-4-4	1/4	9/16x18
1J543-6-4	3/8	11/16x16
1J543-6-6	3/8	11/16x16
1J543-6-6-SM	3/8	11/16x16
1J543-8-6	1/2	13/16x16
1J543-8-8	1/2	13/16x16
1J543-10-8	5/8	1x14
1J543-10-10	5/8	1x14
1J543-10-12	5/8	1x14
1J543-12-12	3/4	1-3/16x12
1J543-16-16	1	1-7/16x12
1J543-20-20	1-1/4	1-11/16x12

### 1J643

Female Seal-Lok™ - Swivel - 22-1/2° Elbow  
End Connection per ISO 8434-3-SWE

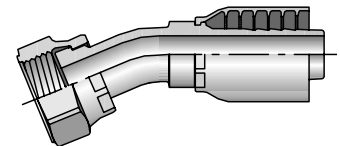

Part Number	Thread inch	Hose ID inch
1J643-8-8	1/2	13/16x16

43 Series: Use with 301LT, 302, 304, 351ST, 351TC, 422, 424, 426, 431, 436, 451TC, 451ST, 471TC, 471ST, 472TC, 482TC, 482ST, 722TC, 881 hoses.

Dimensions and pressures are for reference only and are subject to change.

## 1J743

Female Seal-Lok™ -  
Swivel - 45° Elbow  
ISO 12151-1 - SWE45

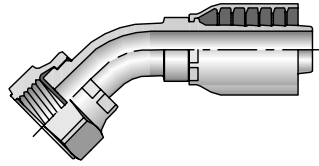

Part Number	Thread inch	Hose ID inch
1J743-4-4	1/4	9/16x18
1J743-4-4-SM	1/4	9/16x18
1J743-4-6	1/4	9/16x18
1J743-6-4	3/8	11/16x16
1J743-6-4-SM	3/8	11/16x16
1J743-6-5	3/8	11/16x16
1J743-6-6	3/8	11/16x16
1J743-6-8	3/8	11/16x16
1J743-8-4	1/2	13/16x16
1J743-8-6	1/2	13/16x16
1J743-8-6-SM	1/2	13/16x16
1J743-8-8	1/2	13/16x16
1J743-8-8-SM	1/2	13/16x16
1J743-8-10	1/2	13/16x16
1J743-10-8	5/8	1x14
1J743-10-10	5/8	1x14
1J743-10-10-SM	5/8	1x14
1J743-10-12	5/8	1x14
1J743-12-8	3/4	1-3/16x12
1J743-12-10	3/4	1-3/16x12
1J743-12-12	3/4	1-3/16x12
1J743-12-12-SM	3/4	1-3/16x12
1J743-12-16	3/4	1-3/16x12
1J743-16-12	1	1-7/16x12
1J743-16-16	1	1-7/16x12
1J743-16-20	1	1-7/16x12
1J743-20-16	1-1/4	1-11/16x12
1J743-20-20	1-1/4	1-11/16x12
1J743-24-20	1-1/2	2x12
1J743-24-24	1-1/2	2x12

## 1J943

Female Seal-Lok™ - Swivel -  
90° Elbow - Short Drop  
ISO 12151-1 - SWES90

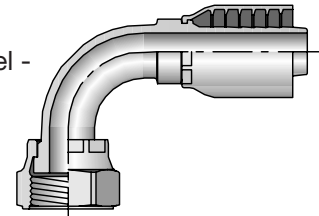

Part Number	Thread inch	Hose ID inch
1J943-4-4	1/4	9/16x18
1J943-4-6	1/4	9/16x18
1J943-6-4	3/8	11/16x16
1J943-6-5	3/8	11/16x16
1J943-6-6	3/8	11/16x16
1J943-6-8	3/8	11/16x16
1J943-8-4	1/2	13/16x16
1J943-8-6	1/2	13/16x16
1J943-8-8	1/2	13/16x16
1J943-8-8-SM	1/2	13/16x16
1J943-8-10	1/2	13/16x16
1J943-10-8	5/8	1x14
1J943-10-10	5/8	1x14
1J943-10-10-SM	5/8	1x14
1J943-10-12	5/8	1x14
1J943-12-8	3/4	1-3/16x12
1J943-12-10	3/4	1-3/16x12
1J943-12-12	3/4	1-3/16x12
1J943-12-16	3/4	1-3/16x12
1J943-16-12	1	1-7/16x12
1J943-16-16	1	1-7/16x12
1J943-16-20	1	1-7/16x12
1J943-20-16	1-1/4	1-11/16x12
1J943-20-20	1-1/4	1-11/16x12
1J943-24-20	1-1/2	2x12
1J943-24-24	1-1/2	2x12

## 1JB43

Male Seal-Lok™ -  
Bulkhead without Locknut -  
(with O-Ring)  
End Connection per ISO 8434-3-BH

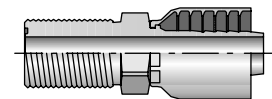

Part Number	Thread inch	Hose ID inch
1JB43-4-4	1/4	9/16x18
1JB43-6-6	3/8	11/16x16
1JB43-8-6	1/2	13/16x16
1JB43-8-8	1/2	13/16x16
1JB43-10-8	5/8	1x14
1JB43-10-10	5/8	1x14
1JB43-12-12	3/4	1-3/16x12

Fittings are stocked less locknut (part no. [WLNL](#)). Locknuts are manufactured by the Parker Tube Fittings Division and must be ordered separately.

43 Series: Use with [301LT](#), [302](#), [304](#), [351ST](#), [351TC](#), [422](#), [424](#), [426](#), [431](#), [436](#), [451TC](#), [451ST](#), [471TC](#), [471ST](#), [472TC](#), [482TC](#), [482ST](#), [722TC](#), [881](#) hoses.

Dimensions and pressures are for reference only and are subject to change.

## 1JC43

Female Seal-Lok™ - Swivel - Short

ISO 12151-1 - SWSA

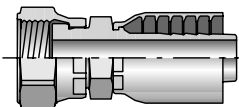

Part Number	Thread inch	Hose ID inch
1JC43-4-4	1/4 9/16x18	1/4
1JC43-4-4-SM	1/4 9/16x18	1/4
1JC43-4-6	1/4 9/16x18	3/8
1JC43-6-4	3/8 11/16x16	1/4
1JC43-6-4-SM	3/8 11/16x16	1/4
1JC43-6-5	3/8 11/16x16	5/16
1JC43-6-6	3/8 11/16x16	3/8
1JC43-6-6-SM	3/8 11/16x16	3/8
1JC43-8-6	1/2 13/16x16	3/8
1JC43-8-6-SM	1/2 13/16x16	3/8
1JC43-8-8	1/2 13/16x16	1/2
1JC43-8-8-SM	1/2 13/16x16	1/2
1JC43-10-8	5/8 1x14	1/2
1JC43-10-8-SM	5/8 1x14	1/2
1JC43-10-10	5/8 1x14	5/8
1JC43-10-10-SM	5/8 1x14	5/8
1JC43-12-8	3/4 1-3/16x12	1/2
1JC43-12-10	3/4 1-3/16x12	5/8
1JC43-12-10-SM	3/4 1-3/16x12	5/8
1JC43-12-12	3/4 1-3/16x12	3/4
1JC43-12-12-SM	3/4 1-3/16x12	3/4
1JC43-12-16	3/4 1-3/16x12	1
1JC43-16-12	1 1-7/16x12	3/4
1JC43-16-16	1 1-7/16x12	1
1JC43-20-20	1-1/4 1-11/16x12	1-1/4

Stainless steel fittings must be assembled with [Karrykrimp 2](#), [PHastkrimp](#), [Superkrimp](#) or [Parkrimp 2](#).

See [www.parker.com/crimpsource](http://www.parker.com/crimpsource) for more information.

## 1JS43

Female Seal-Lok™ - Swivel - Long

ISO 12151-1 SWSB

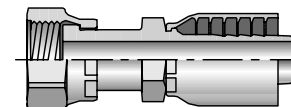

Part Number	Thread inch	Hose ID inch
1JS43-4-4	1/4 9/16x18	1/4
1JS43-4-6	1/4 9/16x18	3/8
1JS43-6-4	3/8 11/16x16	1/4
1JS43-6-6	3/8 11/16x16	3/8
1JS43-6-8	3/8 11/16x16	1/2
1JS43-8-4	1/2 13/16x16	1/4
1JS43-8-6	1/2 13/16x16	3/8
1JS43-8-8	1/2 13/16x16	1/2
1JS43-8-10	1/2 13/16x16	5/8
1JS43-10-6	5/8 1x14	3/8
1JS43-10-8	5/8 1x14	1/2
1JS43-10-10	5/8 1x14	5/8
1JS43-10-12	5/8 1x14	3/4
1JS43-12-8	3/4 1-3/16x12	1/2
1JS43-12-10	3/4 1-3/16x12	5/8
1JS43-12-12	3/4 1-3/16x12	3/4
1JS43-12-16	3/4 1-3/16x12	1
1JS43-16-12	1 1-7/16x12	3/4
1JS43-16-16	1 1-7/16x12	1
1JS43-16-20	1 1-7/16x12	1-1/4
1JS43-20-16	1-1/4 1-11/16x12	1
1JS43-20-20	1-1/4 1-11/16x12	1-1/4
1JS43-24-20	1-1/2 2x12	1-1/4
1JS43-24-24	1-1/2 2x12	1-1/2

## 1L743

Female JIC 37° - Swivel - 45° Elbow - Medium Drop  
ISO 12151-5

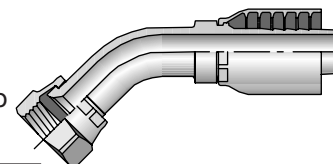

Part Number	Thread inch	Hose ID inch
1L743-6-6	3/8 9/16x18	3/8
1L743-8-8	1/2 3/4x16	1/2
1L743-12-12	3/4 1-1/16x12	3/4
1L743-16-16	1 1-5/16x12	1

## 1L943

Female JIC 37° - Swivel - 90° Elbow - Medium Drop  
ISO 12151-5

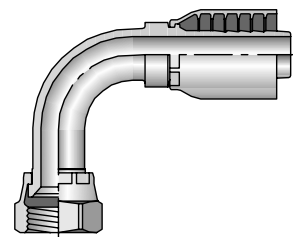

Part Number	Thread inch	Hose ID inch
1L943-4-4	1/4 7/16x20	1/4
1L943-6-4	3/8 9/16x18	1/4
1L943-6-6	3/8 9/16x18	3/8
1L943-8-6	1/2 3/4x16	3/8
1L943-8-8	1/2 3/4x16	1/2
1L943-10-8	5/8 7/8x14	1/2
1L943-12-12	3/4 1-1/16x12	3/4
1L943-16-16	1 1-5/16x12	1

43 Series: Use with [301LT](#), [302](#), [304](#), [351ST](#), [351TC](#), [422](#), [424](#), [426](#), [431](#), [436](#), [451TC](#), [451ST](#), [471TC](#), [471ST](#), [472TC](#), [482TC](#), [482ST](#), [722TC](#), [881](#) hoses.

Dimensions and pressures are for reference only and are subject to change.

[Link to Master Table of Contents](#)

[Link to Section Table of Contents](#)

## 1LB43

Male JIC 37° -  
Bulkhead without Locknut  
ISO 12151-5

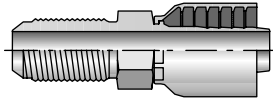

Part Number	Thread inch	Hose ID inch
1LB43-4-4	1/4 7/16x20	1/4
1LB43-6-6	3/8 9/16x18	3/8
1LB43-8-8	1/2 3/4x16	1/2
1LB43-10-10	5/8 7/8x14	5/8
1LB43-12-12	3/4 1-1/16x12	3/4

Fittings are stocked less locknut ([part no. WLN](#)).  
Locknuts are manufactured by the Parker Tube Fittings Division and must be ordered separately.

## 1XU43

Female Metric - Swivel -  
(30° Flare)

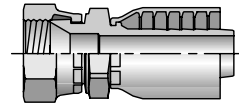

Part Number	Thread mm	Hose ID inch
1XU43-10-10	M24x1,5	5/8
1XU43-12-12	M30x1,5	3/4
1XU43-16-16	M33x1,5	1
1XU43-20-20	M36x1,5	1-1/4
1XU43-24-24	M42x1,5	1-1/2

Japanese Fittings - Female Swivel 30° Flare with Metric Threads.  
All 30° flared fitting sizes are available by combining the 1MU43 fittings in sizes up to -8 with the 1XU43 fittings in sizes -10 and larger.

## 1MU43

Female Metric - Swivel -  
(30° Flare)

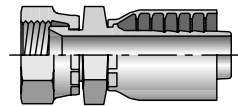

Part Number	Thread mm	Hose ID inch
1MU43-4-4	M14x1,5	1/4
1MU43-6-4	M18x1,5	1/4
1MU43-6-6	M18x1,5	3/8
1MU43-8-8	M22x1,5	1/2

Japanese Fittings - Female Swivel 30° Flare with Metric Threads. All 30° flared fitting sizes are available by combining the 1MU43 fittings in sizes up to -8 with the 1XU43 fittings in sizes -10 and larger.

## 56 Series

### 10156

Male Taper Pipe Rigid

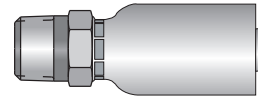

Part Number	Thread inch	Hose ID inch	mm
10156-2-3	1/8-27	3/16	5
10156-4-3	1/4-18	3/16	5
10156-4-4	1/4-18	1/4	6
10156-4-6	1/4-18	3/8	10
10156-6-6	3/8-18	3/8	10
10156-8-8	1/2-14	1/2	13
10156-12-10	3/4-14	5/8	16
10156-12-12	3/4-14	3/4	19
10156-16-16	1-11-1/2	1	25

Construction: Steel. Add "C" for Stainless Steel.  
**Note:** Metric hex parts are available upon request.

## 1S243

Female NPTF Pipe -  
Swivel

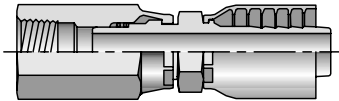

Part Number	Thread inch	Hose ID inch
1S243-4-4	1/4x18	1/4

## 1UT43

Male BSP Taper Pipe -  
Rigid - (60° Cone)  
B8363 Code R

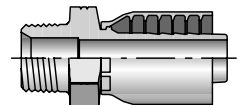

Part Number	Thread inch	Hose ID inch
1UT43-4-4	1/4x19	1/4
1UT43-6-6	3/8x19	3/8
1UT43-8-8	1/2x14	1/2
1UT43-12-12	3/4x14	3/4
1UT43-16-16	1x11	1
1UT43-20-20	1-1/4x11	1-1/4

### 10256

Female Taper Pipe Rigid

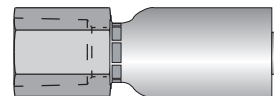

Part Number	Thread inch	Hose ID inch	mm
10256-4-4	1/4-18	1/4	6

Construction: Steel. Add "C" for Stainless Steel.

56 Series: Use with 510C, 518C, 540N, 548N, 560, 590, D6R hoses.

43 Series: Use with 301LT, 302, 304, 351ST, 351TC, 422, 424, 426, 431, 436, 451TC, 451ST, 471TC, 471ST, 472TC, 482TC, 482ST, 722TC, 881, S4 hoses.

Dimensions and pressures are for reference only and are subject to change.



## 10356

Male (JIC) 37° - Rigid

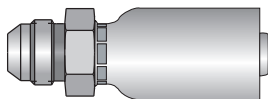

Part Number	Thread inch	Hose ID	
		inch	mm
10356-4-3	7/16-20	3/16	5
10356-4-4	7/16-20	1/4	6
10356-5-4	1/2-20	1/4	6
10356-6-4	9/16-18	1/4	6
10356-6-5	9/16-18	5/16	8
10356-5-6	1/2-20	3/8	10
10356-6-6	9/16-18	3/8	10
10356-8-6	3/4-16	3/8	10
10356-8-8	3/4-16	1/2	13
10356-10-8	7/8-14	1/2	13
10356-12-10	1-1/16-12	5/8	16
10356-12-12	1-1/16-12	3/4	19
10356-16-16	1-5/16-12	1	25

Construction: Steel. Add "C" for Stainless Steel.

Note: Metric hex parts are available upon request.

## 10456

Male SAE 45° - Rigid

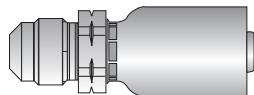

Part Number	Thread inch	Hose ID	
		inch	mm
10456-4-3	7/16-20	3/16	5
10456-5-4	1/2-20	1/4	6
10456-6-5	5/8-18	5/16	8
10456-6-6	5/8-18	1/2	13
10456-6-8	5/8-18	1/2	13
10456-8-8	3/4-16	1/2	13
10456-12-12	1-1/16-14	3/4	19

Construction: Steel. Add "C" for Stainless Steel.

## 10556

Male Straight Thread O-Ring (BUNA N O-Ring included)

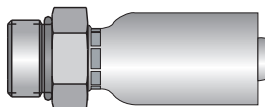

Part Number	Thread inch	Hose ID	
		inch	mm
10556-4-3	7/16-20	3/16	4
10556-6-3	9/16-18	3/16	4
10556-4-4	7/16-20	1/4	6
10556-5-4	1/2-20	1/4	6
10556-6-4	9/16-18	1/4	6
10556-4-5	7/16-20	5/16	8
10556-5-5	1/2-20	5/16	8
10556-6-6	9/16-18	3/8	10
10556-8-6	3/4-16	3/8	10
10556-8-8	3/4-16	1/2	12
10556-10-8	7/8-14	1/2	12

Construction: Steel. Add "C" for Stainless Steel.

Note: Metric hex parts are available upon request.

## 10656

SAE (JIC) 37° Swivel

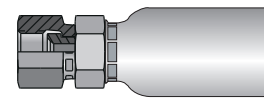

Part Number	Thread inch	Hose ID	
		inch	mm
10656-3-3	3/8-24	3/16	5
10656-4-3	7/16-20	3/16	5
10656-5-3	1/2-20	3/16	5
10656-2-4	3/8-24	1/4	6
10656-4-4	7/16-20	1/4	6
10656-5-4	1/2-20	1/4	6
10656-6-4	9/16-18	1/4	6
10656-4-5	7/16-20	5/16	8
10656-5-5	1/2-20	5/16	8
10656-6-5	9/16-18	5/16	8
10656-4-6	7/16-20	3/8	10
10656-5-6	1/2-20	3/8	10
10656-6-6	9/16-18	3/8	10
10656-8-6	3/4-16	3/8	10
10656-6-8	9/16-18	1/2	13
10656-8-8	3/4-16	1/2	13
10656-10-8	7/8-14	1/2	13
10656-8-10	3/4-16	5/8	16
10656-10-10	7/8-14	5/8	16
10656-12-10	1-1/16-12	5/8	16
10656-10-12	7/8-14	3/4	19
10656-12-12	1-1/16-12	3/4	19
10656-16-12	1-5/16-12	3/4	19
10656-16-16	1-5/16-12	1	25
10656-20-16	1-5/8-12	1	25

Construction: Steel. Add "C" for Stainless Steel.

Note: Metric hex parts are available upon request.

Sizes -4, -5, -8 and -10 incorporate a dual seat.

## 10756

Female Pipe Swivel

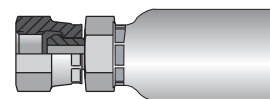

Part Number	Thread inch	Hose ID	
		inch	mm
10756-4-4	1/4-18	1/4	6
10756-4-5	1/4-18	5/16	8
10756-6-6	3/8-18	3/8	10
10756-8-8	1/2-14	1/2	13
10756-12-12	3/4-14	3/4	19
10756-16-16	1-11/12	1	25

Construction: Steel. Add "C" for Stainless Steel.

## 10856

Female SAE 45° Swivel

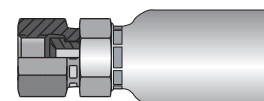

Part Number	Thread inch	Hose ID	
		inch	mm
10856-6-4	5/8-18	1/4	6
10856-6-5	5/8-18	5/16	8
10856-6-6	5/8-18	3/8	10
10856-12-12	1-1/16-14	3/4	19

Construction: Steel. Add "C" for Stainless Steel.

56 Series: Use with 510C, 518C, 540N, 548N, 560, 590, D6R hoses.  
Dimensions and pressures are for reference only and are subject to change.

## 10C56

Metric Female Swivel 24° With O-Ring 45° Elbow  
Light Series, ISO 12151-2

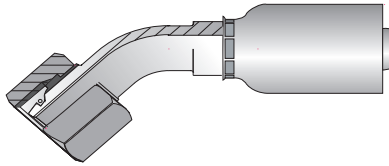

Part Number	Thread	Hose ID	
		mm	inch
10C56-6-3	M14x1.5	5	3/16
10C56-8-3	M16x1.5	5	3/16
10C56-10-4	M18x1.5	6	1/4
10C56-12-5	M20x1.5	8	5/16
10C56-12-6	M20x1.5	10	3/8
10C56-16-8	M24x1.5	13	1/2

Construction: Steel. Add "C" for Stainless Steel.

## 11256

SAE Flareless Swivel

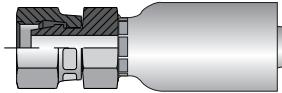

Part Number	Thread	Hose ID	
		inch	mm
11256-6-4	9/16-18	1/4	6
11256-6-6	9/16-18	3/8	10
11256-8-6	3/4-16	3/8	10

Construction: Steel. Add "C" for Stainless Steel.

## 11356

Male Pipe Swivel

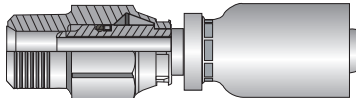

Part Number	Thread	Hose ID	
		inch	mm
11356-2-3	1/8-27	3/16	5
11356-4-3	1/4-18	3/16	5
11356-4-4	1/4-18	1/4	6
11356-4-5	1/4-18	5/16	8
11356-6-6	3/8-18	3/8	10
11356-8-6	1/2-14	3/8	10
11356-8-8	1/2-14	1/2	13
11356-12-12	3/4-14	3/4	19
11356-16-16	1-11-1/2	1	25

Construction: Steel. Add "C" for Stainless Steel.

**Note:** For use with petroleum based fluids.

**WARNING:** Fittings allow minor movement to relieve stress on hose but are not recommended for continued or extensive swiveling. Not recommended for use in CNG applications.

## 11C56

Metric Female Swivel 24° With O-Ring 90° Elbow  
Light Series, ISO 12151-2

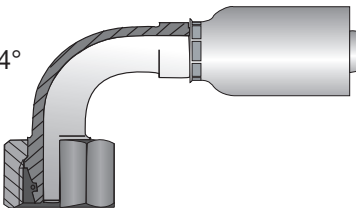

Part Number	Thread	Hose ID	
		mm	inch
11C56-8-3	M16x1.5	5	3/16
11C56-10-4	M18x1.5	6	1/4
11C56-12-5	M20x1.5	8	5/16
11C56-12-6	M20x1.5	10	3/8
11C56-16-8	M24x1.5	13	1/2

Construction: Steel. Add "C" for Stainless Steel.

## 13756

Female JIC 37° Swivel 45° Elbow

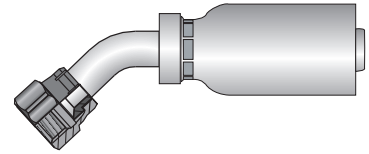

Part Number	Thread	Hose ID	
		inch	mm
13756-4-3	7/16-20	3/16	5
13756-4-4	7/16-20	1/4	6
13756-5-4	1/2-20	1/4	6
13756-6-4	9/16-18	1/4	6
13756-6-5	9/16-18	5/16	8
13756-6-6	9/16-18	3/8	10
13756-8-6	3/4-16	3/8	10
13756-8-8	3/4-16	1/2	13
13756-10-8	7/8-14	1/2	13
13756-10-10	7/8-14	5/8	16
13756-12-10	1-1/16-12	5/8	16
13756-12-12	1-1/16-12	3/4	19
13756-16-16	1-5/16-12	1	25

Construction: Steel. Add "C" for Stainless Steel.

**Note:** Metric hex parts are available upon request.

## 13956

Female JIC 37° Swivel 90° Elbow Short Drop

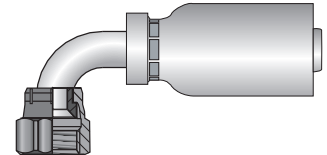

Part Number	Thread	Hose ID	
		inch	mm
13956-4-3	7/16-20	3/16	5
13956-4-4	7/16-20	1/4	6
13956-5-4	5/8-20	1/4	6
13956-6-4	9/16-18	1/4	6
13956-6-5	9/16-18	5/16	8
13956-6-6	9/16-18	3/8	10
13956-8-6	3/4-16	3/8	10
13956-8-8	3/4-16	1/2	13
13956-10-8	7/8-14	1/2	13
13956-10-10	7/8-14	5/8	16
13956-12-10	1-1/16-12	5/8	16
13956-12-12	1-1/16-12	3/4	19
13956-16-16	1-5/16-12	1	25

Construction: Steel. Add "C" for Stainless Steel.

**Note:** Metric hex parts are available upon request.

## 13E56

Male (JIC) 37° Long

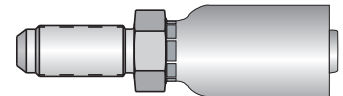

Part Number	Thread	Hose ID	
		inch	mm
13E56-4-4	7/16-20	1/4	6
13E56-6-5	9/16-18	5/16	8
13E56-6-6	9/16-18	3/8	10
13E56-8-8	3/4-16	1/2	13

Construction: Steel. Add "C" for Stainless Steel.

**Note:** Bulkhead Locknut sold separately. WLN Locknuts are manufactured by the Tube Fittings Division. Refer to Catalog 4300 for additional information.

56 Series: Use with 510C, 518C, 540N, 548N, 560, 590, D6R hoses.

Dimensions and pressures are for reference only and are subject to change.

### 14156

Female JIC 37° Swivel  
90° Elbow Long Drop

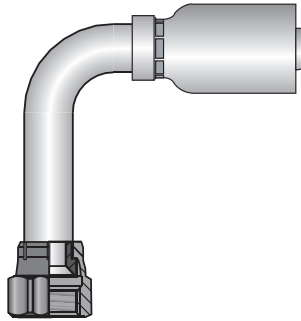

Part Number	Thread inch	Hose ID	
		inch	mm
14156-4-3	7/16-20	3/16	5
14156-4-4	7/16-20	1/4	6
14156-5-4	1/2-20	1/4	6
14156-6-4	9/16-18	1/4	6
14156-6-5	9/16-18	5/16	8
14156-6-6	9/16-18	3/8	10
14156-8-6	3/4-16	3/8	10
14156-8-8	3/4-16	1/2	13
14156-10-8	7/8-14	1/2	13
14156-12-12	1-1/16-12	3/4	19
14156-16-16	1-5/16-12	1	25

Construction: Steel. Add "C" for Stainless Steel.

### 16756

SAE Male Inverted Swivel  
45° Elbow

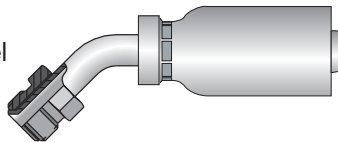

Part Number	Thread inch	Hose ID	
		inch	mm
16756-6-6	5/8-18	3/8	10

Construction: Steel. Add "C" for Stainless Steel.

### 16956

SAE Male Inverted Swivel  
90° Elbow

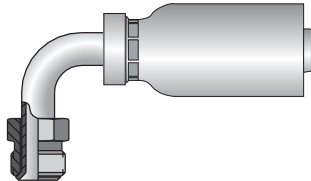

Part Number	Thread inch	Hose ID	
		inch	mm
16956-6-6	5/8-18	3/8	10

Construction: Steel. Add "C" for Stainless Steel.

### 19256

Female BSP Parallel Pipe  
Swivel Straight (60° Cone)

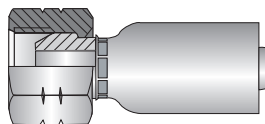

Part Number	Thread	Hose ID	
		mm	inch
19256-4-3	G 1/4	5	3/16
19256-2-4	G 1/8	6	1/4
19256-4-4	G 1/4	6	1/4
19256-6-4	G 3/8	6	1/4
19256-4-5	G 1/4	8	5/16
19256-6-5	G 3/8	8	5/16
19256-6-6	G 3/8	10	3/8
19256-8-6	G 1/2	10	3/8
19256-6-8	G 3/8	13	1/2
19256-8-8	G 1/2	13	1/2
19256-10-8	G 5/8	13	1/2
19256-12-12	G 3/4	19	3/4
19256-16-16	G 1	25	1

Construction: Steel. Add "C" for Stainless Steel.

### 1AL56

A-LOK® Compression  
(With Nut and Ferrule)

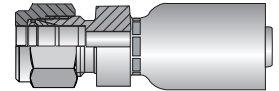

Part Number	Thread Size	Tube OD		Hose ID	
		inch	mm	inch	mm
1AL56-4-4	7/16-20	1/4	6	1/4	6
1AL56-6-6	9/16-20	3/8	10	3/8	10
1AL56-8-8	3/4-20	1/2	13	3/8	10

Construction: 316 Stainless nipple and shell.

Note: Nut part No. is XNUX or XNUX-316 for stainless steel.

Front ferrule part No. is XFFX or XFFX-316 for stainless steel.

Back ferrule part No. is XBFX or XBFX-316 for stainless steel.

X denotes dash size.

### 1B156

Female BSP  
Parallel Pipe  
Swivel 45° Elbow  
(60° Cone)

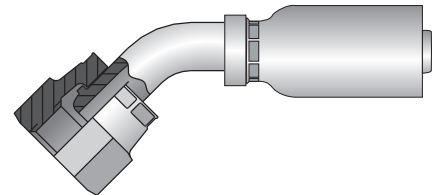

ISO 228-1

Part Number	Thread	Hose ID	
		mm	inch
1B156-4-3	G 1/4	5	3/16
1B156-4-4	G 1/4	6	1/4
1B156-6-5	G 3/8	8	5/16
1B156-6-6	G 3/8	10	3/8
1B156-8-8	G 1/2	13	1/2
1B156-12-12	G 3/4	19	3/4
1B156-16-16	G 1	25	1

Construction: Steel. Add "C" for Stainless Steel.

### 1B256

Female BSP Parallel  
Pipe Swivel 90° Elbow  
(60° Cone)

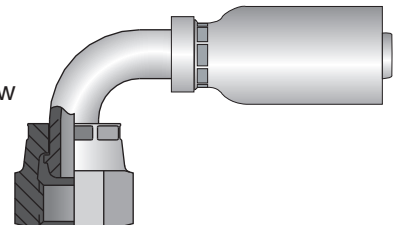

ISO 228-1

Part Number	Thread	Hose ID	
		mm	inch
1B256-4-3	G 1/4	5	3/16
1B256-4-4	G 1/4	6	1/4
1B256-4-5	G 1/4	8	5/16
1B256-6-5	G 3/8	8	5/16
1B256-6-6	G 3/8	10	3/8
1B256-8-8	G 1/2	13	1/2
1B256-12-12	G 3/4	19	3/4
1B256-16-16	G 1	25	1

Construction: Steel. Add "C" for Stainless Steel.

56 Series: Use with 510C, 518C, 540N, 548N, 560, 590, D6R hoses.

Dimensions and pressures are for reference only and are subject to change.

### 1B456

Female BSP Swivel  
90° Elbow Block Type  
(60° Cone)  
ISO 228-1

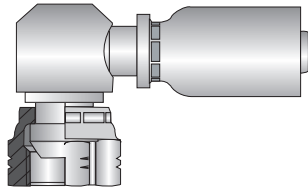

Part Number	Thread	Hose ID	
		mm	inch
1B256-4-4	G 1/4	6	1/4
1B256-6-6	G 3/8	10	3/8
1B256-8-8	G 1/2	13	1/2

Construction: Steel. Add "C" for Stainless Steel.

### 1C356

Metric Female Swivel Nut  
Light Series, 24°/60°

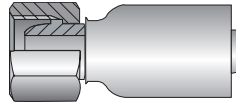

Part Number	Thread	Hose ID	
		mm	inch
1C356-6-3	M12x1.5	5	3/16
1C356-8-4	M14x1.5	6	1/4
1C356-10-4	M16x1.5	6	1/4
1C356-10-5	M16x1.5	8	5/16
1C356-12-5	M18x1.5	8	5/16
1C356-10-6	M16x1.5	10	3/8
1C356-12-6	M18x1.5	10	3/8
1C356-15-6	M22x1.5	10	3/8
1C356-15-8	M22x1.5	13	1/2
1C356-18-10	M26x1.5	16	5/8
1C356-18-12	M26x1.5	19	3/4
1C356-22-12	M30x2	19	3/4

Construction: Steel. Add "C" for Stainless Steel.

### 1C456

Metric Female  
Swivel 45° Elbow  
Light Series, 24°/60°

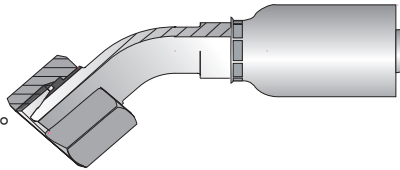

Part Number	Thread	Hose ID	
		mm	inch
1C456-6-3	M12x1.5	5	3/16
1C456-8-4	M14x1.5	6	1/4
1C456-10-5	M16x1.5	8	5/16
1C456-10-6	M16x1.5	10	3/8
1C456-12-6	M18x1.5	10	3/8
1C456-15-8	M22x1.5	13	1/2

Construction: Steel. Add "C" for Stainless Steel.

### 1C556

Metric Female Swivel  
95° Elbow  
Light Series, 24°/60°

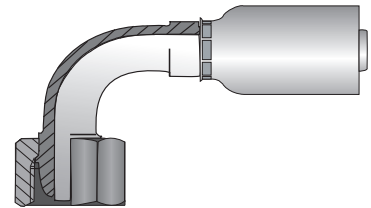

Part Number	Thread	Hose ID	
		mm	inch
1C556-6-3	M12x1.5	5	3/16
1C556-8-4	M14x1.5	6	1/4
1C556-10-4	M16x1.5	6	1/4
1C556-12-5	M18x1.5	8	5/16
1C556-10-6	M16x1.5	10	3/8
1C556-12-6	M18x1.5	10	3/8
1C556-15-8	M22x1.5	13	1/2
1C556-18-12	M26x1.5	19	3/4

Construction: Steel. Add "C" for Stainless Steel.

### 1C656

Female Metric Swivel DIN 20078  
Heavy Series (Without O-Ring)  
ISO 8434-1

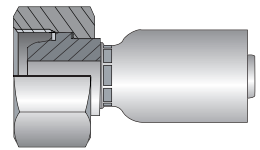

Part Number	Thread	Hose ID	
		mm	inch
1C656-8-3	M16x1.5	5	3/16
1C656-10-4	M18x1.5	6	1/4
1C656-12-5	M20x1.5	8	5/16
1C656-12-6	M20x1.5	10	3/8
1C656-14-6	M22x1.5	10	3/8
1C656-16-8	M24x1.5	10	1/2
1C656-20-12	M30x2	13	3/4

Construction: Steel. Add "C" for Stainless Steel.

### 1C956

Female Metric Swivel DIN 20078  
Heavy Series, (With O-Ring)  
ISO 12151-2-SWS

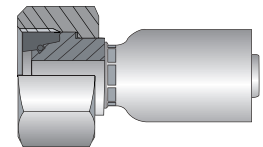

Part Number	Thread	Hose ID	
		mm	inch
1C956-8-3	M16x1.5	5	3/16
1C956-8-4	M16x1.5	6	1/4
1C956-10-4	M18x1.5	6	1/4
1C956-12-4	M20x1.5	6	1/4
1C956-10-5	M18x1.5	8	5/16
1C956-12-5	M20x1.5	8	5/16
1C956-12-6	M20x1.5	10	3/8
1C956-14-6	M22x1.5	10	3/8
1C956-16-8	M24x1.5	13	1/2
1C956-20-12	M30x2	19	3/4
1C956-25-12	M36x2	19	3/4

Construction: Steel. Add "C" for Stainless Steel.

56 Series: Use with 510C, 518C, 540N, 548N, 560, 590, D6R hoses.

Dimensions and pressures are for reference only and are subject to change.

## 1CA56

Metric Female Swivel 24°  
With O-Ring  
Light Series, ISO 12151-2

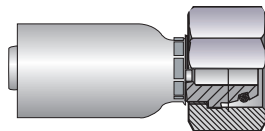

Part Number	Thread	Hose ID	
		mm	inch
1CA56-6-3	M12x1.5	5	3/16
1CA56-6-4	M12x1.5	6	1/4
1CA56-8-4	M14x1.5	6	1/4
1CA56-10-4	M16x1.5	6	1/4
1CA56-12-4	M18x1.5	6	1/4
1CA56-10-5	M16x1.5	8	5/16
1CA56-12-5	M18x1.5	8	5/16
1CA56-10-6	M16x1.5	10	3/8
1CA56-12-6	M18x1.5	10	3/8
1CA56-15-6	M22x1.5	10	3/8
1CA56-12-8	M18x1.5	13	1/2
1CA56-15-8	M22x1.5	13	1/2
1CA56-18-8	M26x1.5	13	1/2
1CA56-18-10	M26x1.5	16	5/8
1CA56-18-12	M26x1.5	19	3/4
1CA56-22-12	M30x2	19	3/4
1CA56-28-16	M36x2	25	1

Construction: Steel. Add "C" for Stainless Steel.

## 1CE56

Metric Female Swivel  
24° With O-Ring  
45° Elbow  
Light Series, ISO 12151-2

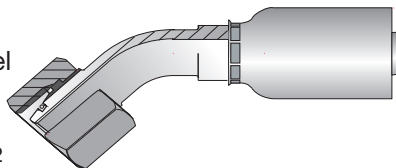

Part Number	Thread	Hose ID	
		mm	inch
1CE56-6-3	M12x1.5	5	3/16
1CE56-8-4	M14x1.5	6	1/4
1CE56-10-4	M16x1.5	6	1/4
1CE56-10-5	M16x1.5	8	5/16
1CE56-10-6	M16x1.5	10	3/8
1CE56-12-6	M18x1.5	10	3/8
1CE56-15-8	M22x1.5	13	1/2
1CE56-18-10	M26x1.5	16	5/8
1CE56-18-12	M26x1.5	19	3.4
1CE56-22-12	M30x2	19	3.4
1CE56-28-16	M36x2	25	1

Construction: Steel. Add "C" for Stainless Steel.

## 1CF56

Metric Female Swivel 24°  
With O-Ring 90° Elbow  
Light Series, ISO 12151-2

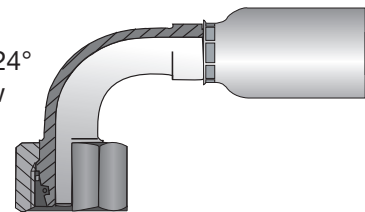

Part Number	Thread	Hose ID	
		mm	inch
1CF56-6-3	M12x1.5	5	3/16
1CF56-6-4	M12x1.5	6	1/4
1CF56-8-4	M14x1.5	6	1/4
1CF56-10-4	M16x1.5	6	1/4
1CF56-10-5	M16x1.5	8	5/16
1CF56-12-5	M18x1.5	8	5/16
1CF56-10-6	M16x1.5	10	3/8
1CF56-12-6	M18x1.5	10	3/8
1CF56-15-8	M22x1.5	13	1/2
1CF56-18-10	M26x1.5	16	5/8
1CF56-22-12	M30x2	19	3/4
1CF56-28-16	M36x2	25	1

Construction: Steel. Add "C" for Stainless Steel.

## 1D056

Male Stud DIN 20078  
Light Series, ISO 8434-1

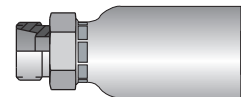

Part Number	Thread	Hose ID	
		mm	inch
1D056-6-3	M12x1.5	5	3/16
1D056-6-4	M12x1.5	6	1/4
1D056-8-4	M14x1.5	6	1/4
1D056-10-5	M16x1.5	8	5/16
1D056-12-5	M18x1.5	8	5/16
1D056-10-6	M16x1.5	10	3/8
1D056-12-6	M18x1.5	10	3/8
1D056-15-6	M22x1.5	10	3/8
1D056-15-8	M22x1.5	13	1/2
1D056-18-10	M26x1.5	16	5/8
1D056-22-12	M30x2	19	3/4
1D056-28-16	M36x2	25	1

Construction: Steel. Add "C" for Stainless Steel.

## 1D256

Metric Male Stud 24°  
Light Series, ISO 12151-2

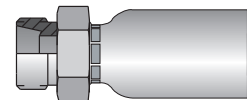

Part Number	Thread	Hose ID	
		mm	inch
1D256-8-3	M16x1.5	5	3/16
1D256-10-4	M18x1.5	6	1/4
1D256-10-5	M18x1.5	8	5/16
1D256-12-5	M20x1.5	8	5/16
1D256-12-6	M20x1.5	10	3/8
1D256-14-6	M22x1.5	10	3/8
1D256-16-6	M24x1.5	10	3/8
1D256-16-8	M24x1.5	13	1/2
1D256-20-12	M30x2	19	3/4

Construction: Steel. Add "C" for Stainless Steel.

56 Series: Use with 510C, 518C, 540N, 548N, 560, 590, D6R hoses.

Dimensions and pressures are for reference only and are subject to change.

### 1D956

Male BSPP - Straight (60° Cone)  
ISO 228-1

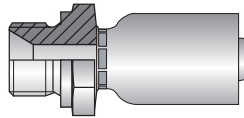

Part Number	Thread	Hose ID	
		mm	inch
1D956-4-3	G 1/4	5	3/16
1D956-4-4	G 1/4	6	1/4
1D956-6-5	G 3/8	8	5/16
1D956-6-6	G 3/8	10	3/8
1D956-8-8	G 1/2	13	1/2
1D956-12-12	G 3/4	19	3/4
1D956-16-16	G 1	25	1

Construction: Steel. Add "C" for Stainless Steel.

### 1J056

Male Seal-Lok™ Rigid  
Straight w/O-Ring  
ISO 12151-1-S

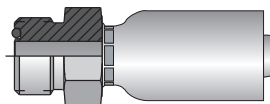

Part Number	Thread inch	Hose ID	
		inch	mm
1J056-4-4	9/16-18	1/4	6
1J056-6-4	11/16-16	1/4	6
1J056-6-6	11/16-16	3/8	10
1J056-8-6	13/16-16	1/2	13
1J056-8-8	13/16-16	1/2	13

Construction: Steel. Add "C" for Stainless Steel.

Note: Metric hex parts are available upon request.

### 1J156

Female Seal-Lok™ Swivel  
90° Elbow Long Drop  
ISO 12151-1-SWEL90

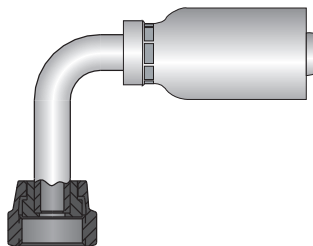

Part Number	Thread inch	Hose ID	
		inch	mm
1J156-4-3	9/16-18	3/16	5
1J156-4-4	9/16-18	1/4	6
1J156-6-4	11/16-16	1/4	6
1J156-6-6	11/16-16	3/8	10
1J156-8-6	13/16-16	3/8	10
1J156-8-8	13/16-16	1/2	10
1J156-12-12	1-3/16-12	3/4	19
1J156-16-16	1-7/16-12	1	25

Construction: Steel. Add "C" for Stainless Steel.

Note: Metric hex parts are available upon request.

### 1J256

Female Seal-Lok™  
Swivel 30° Elbow

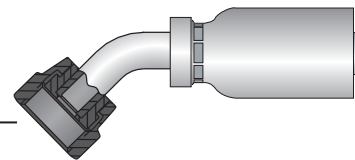

Part Number	Thread inch	Hose ID	
		inch	mm
1J256-8-8	13/16-16	1/2	13

Construction: Steel. Add "C" for Stainless Steel.

### 1J556

Female Seal-Lok™ Swivel  
90° Elbow Medium Drop  
ISO 12151-1-SWEM90

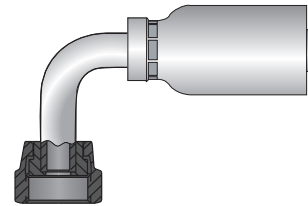

Part Number	Thread inch	Hose ID	
		inch	mm
1J556-4-3	9/16-18	3/16	5
1J556-4-4	9/16-18	1/4	6
1J556-6-4	11/16-16	1/4	6
1J556-6-5	11/16-16	5/16	8
1J556-6-6	11/16-16	3/8	10
1J556-8-6	13/16-16	3/8	10
1J556-8-8	13/16-16	1/2	13
1J556-10-8	1-14	1/2	13
1J556-10-10	1-14	5/8	16
1J556-12-12	1-3/16-12	3/4	19
1J556-16-16	1-7/16-12	1	25

Construction: Steel. Add "C" for Stainless Steel.

Note: Metric hex parts are available upon request.

### 1J756

Female Seal-Lok™ Swivel  
45° Elbow  
ISO 12151-1-SWE45

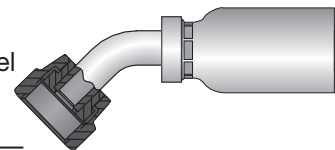

Part Number	Thread inch	Hose ID	
		inch	mm
1J756-4-3	9/16-18	3/16	5
1J756-4-4	9/16-18	1/4	6
1J756-6-4	11/16-16	1/4	6
1J756-6-5	11/16-16	5/16	8
1J756-4-6	9/16-18	3/8	10
1J756-6-6	11/16-16	3/8	10
1J756-8-6	13/16-16	3/8	10
1J756-8-8	13/16-16	1/2	13
1J756-10-10	1-14	5/8	16
1J756-12-12	1-3/16-12	3/4	19
1J756-16-16	1-7/16-12	1	25

Construction: Steel. Add "C" for Stainless Steel.

Note: Metric hex parts are available upon request.

56 Series: Use with 510C, 518C, 540N, 548N, 560, 590, D6R hoses.

Dimensions and pressures are for reference only and are subject to change.

## 1J956

Female Seal-Lok™ Swivel  
90° Elbow Short Drop  
ISO 12151-1-SWES90

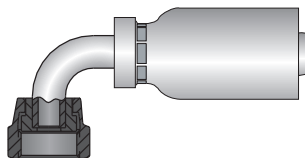

Part Number	Thread inch	Hose ID	
		inch	mm
1J956-4-3	9/16-18	3/16	5
1J956-4-4	9/16-18	1/4	6
1J956-6-4	11/16-16	1/4	6
1J956-6-5	11/16-16	5/16	8
1J956-6-6	11/16-16	3/8	10
1J956-8-6	13/16-16	3/8	10
1J956-8-8	13/16-16	1/2	13
1J956-10-8	1-14	1/2	13
1J956-10-10	1-14	5/8	16
1J956-12-12	1-3/16-12	3/4	19
1J956-16-16	1-7/16-12	1	25

Construction: Steel. Add "C" for Stainless Steel.  
Note: Metric hex parts are available upon request.

## 1JS56

Female Seal-Lok™ Straight  
ISO 12151-1-SWSB

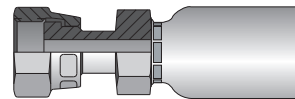

Part Number	Thread inch	Hose ID	
		inch	mm
1JS56-4-3	9/16-18	3/16	5
1JS56-4-4	9/16-18	1/4	6
1JS56-6-4	11/16-16	1/4	6
1JS56-6-5	11/16-16	5/16	8
1JS56-6-6	11/16-16	3/8	10
1JS56-8-6	13/16-16	3/8	10
1JS56-8-8	11/16-16	1/2	13
1JS56-8-8	13/16-16	1/2	13
1JS56-10-8	1-14	1/2	13
1JS56-10-10	1-14	5/8	16
1JS56-12-12	1-3/16-12	3/4	19
1JS56-16-16	1-7/16-12	1	25

Construction: Steel. Add "C" for Stainless Steel.  
Note: Metric hex parts are available upon request.

## 1JC56

Female Seal-Lok™ Straight -  
Swivel - Short  
ISO 12151-1-SWSA

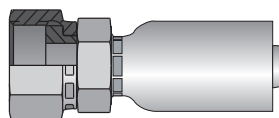

Part Number	Thread inch	Hose ID	
		inch	mm
1JC56-4-3	9/16-18	3/16	5
1JC56-4-4	9/16-18	1/4	6
1JC56-6-4	11/16-16	1/4	6
1JC56-4-5	9/16-18	5/16	8
1JC56-6-5	11/16-16	5/16	8
1JC56-4-6	9/16-18	3/8	10
1JC56-6-6	11/16-16	3/8	10
1JC56-8-6	13/16-16	3/8	10
1JC56-8-8	13/16-16	1/2	13
1JC56-10-8	1-14	1/2	13
1JC56-10-10	1-14	5/8	16
1JC56-12-10	1-3/16-12	5/8	16
1JC56-10-12	1-14	3/4	19
1JC56-12-12	1-3/16-12	3/4	19
1JC56-16-16	1-7/16-12	1	25

Construction: Steel. Add "C" for Stainless Steel.  
Note: Metric hex parts are available upon request.

## 1L956

Female JIC 37° Swivel  
90° Elbow Medium Drop

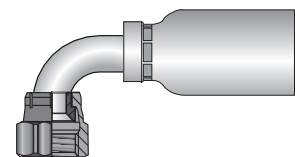

Part Number	Thread inch	Hose ID	
		inch	mm
1L956-4-3	7/16-20	3/16	5
1L956-4-4	7/16-20	1/4	6
1L956-5-4	1/2-20	1/4	6
1L956-6-5	9/16-18	5/16	8
1L956-6-6	9/16-18	3/8	10
1L956-8-6	3/4-16	3/8	10
1L956-8-8	3/4-16	1/2	13
1L956-10-8	7/8-14	1/2	13
1L956-12-12	1-1/16-12	3/4	19
1L956-16-16	1-5/16-12	1	25

Construction: Steel. Add "C" for Stainless Steel.

## 1TU56

Universal Inch Tube Stub End

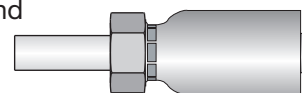

Part Number	Thread inch	Hose ID	
		inch	mm
1TU56-4-4	1/4	1/4	6
1TU56-6-4	3/8	1/4	6
1TU56-6-6	3/8	3/8	10
1TU56-8-8	1/2	1/2	13
1TU56-12-12	3/4	3/4	19
1TU56-16-16	1	1	25

Construction: Steel. Add "C" for Stainless Steel.  
Note: Use with A-LOK & CPI nuts, sleeves and adapters. These components are manufactured by Parker's Instrumentation Connectors Division. Refer to catalogs 4230 & 4233 for additional information.

56 Series: Use with 510C, 518C, 540N, 548N, 560, 590, D6R hoses.  
Dimensions and pressures are for reference only and are subject to change.

## 71 Series

### 10171

Male NPTF Pipe - Rigid

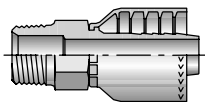

Part Number	Thread inch	Hose ID inch
10171-6-6	3/8x18	3/8
10171-8-8	1/2x14	1/2
10171-12-8	3/4x14	1/2
10171-12-12	3/4x14	3/4
10171-16-12	1x11-1/2	3/4
10171-16-16	1x11-1/2	1
10171-20-16	1-1/4x11-1/2	1
10171-20-20	1-1/4x11-1/2	1-1/4
10171-24-20	1-1/2x11-1/2	1-1/4
10171-24-24	1-1/2x11-1/2	1-1/2
10171-32-32	2x11-1/2	2

### 10371

Male JIC 37° - Rigid

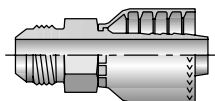

Part Number	Thread inch	Hose ID inch
10371-6-6	3/8 9/16x18	3/8
10371-8-6	1/2 3/4x16	3/8
10371-8-8	1/2 3/4x16	1/2
10371-10-8	5/8 7/8x14	1/2
10371-10-10	5/8 7/8x14	5/8
10371-12-12	3/4 1-1/16x12	3/4
10371-14-12	7/8 1-3/16x12	3/4
10371-16-12	1 1-5/16x12	3/4
10371-16-16	1 1-5/16x12	1
10371-20-16	1-1/4 1-5/8x12	1
10371-20-20	1-1/4 1-5/8x12	1-1/4

### 10571

Male SAE Straight Thread with O-Ring - Rigid

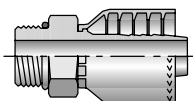

Part Number	Thread inch	Hose ID inch
10571-8-8	1/2 3/4x16	1/2
10571-12-12	3/4 1-1/16x12	3/4
10571-16-16	1 1-5/16x12	1
10571-20-20	1-1/4 1-5/8x12	1-1/4

### 10671

Female JIC 37° - Swivel

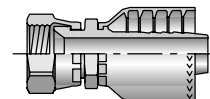

Part Number	Thread inch	Hose ID inch
10671-6-6	3/8 9/16x18	3/8
10671-8-6	1/2 3/4x16	3/8
10671-8-8	1/2 3/4x16	1/2
10671-10-8	5/8 7/8x14	1/2
10671-10-10	5/8 7/8x14	5/8
10671-10-12	5/8 7/8x14	3/4
10671-12-8	3/4 1-1/16x12	1/2
10671-12-10	3/4 1-1/16x12	5/8
10671-12-12	3/4 1-1/16x12	3/4
10671-12-16	3/4 1-1/16x12	1
10671-14-12	7/8 1-3/16x12	3/4
10671-16-12	1 1-5/16x12	3/4
10671-16-16	1 1-5/16x12	1
10671-20-16	1-1/4 1-5/8x12	1
10671-20-20	1-1/4 1-5/8x12	1-1/4
10671-24-20	1-1/2 1-7/8x12	1-1/4
10671-24-24	1-1/2 1-7/8x12	1-1/2
10671-32-32	2 2-1/2x12	2

Stainless steel fittings must be assembled with [Karrykrimp 2](#), [PHastkrimp](#), [Superkrimp](#) or [Parkrimp 2](#). See [www.parker.com/crimpsource](http://www.parker.com/crimpsource) for more information.

### 11571

SAE Code 61 Flange Head  
ISO 12151-3 - S - L

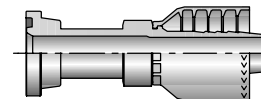

Part Number	Flange inch	Hose ID inch
11571-8-8	1/2	1/2
11571-10-10	5/8	5/8
11571-12-8	3/4	1/2
11571-12-12	3/4	3/4
11571-16-12	1	3/4
11571-16-16	1	1
11571-20-12	1-1/4	3/4
11571-20-16	1-1/4	1
11571-20-20	1-1/4	1-1/4
11571-20-24	1-1/4	1-1/2
11571-24-16	1-1/2	1
11571-24-20	1-1/2	1-1/4
11571-24-24	1-1/2	1-1/2
11571-24-32	1-1/2	2
11571-32-20	2	1-1/4
11571-32-24	2	1-1/2
11571-32-32	2	2
11571-40-32	2-1/2	2

71 Series: Use with [711](#), [721](#), [721TC](#), [721ST](#), [722TC](#), [772TC](#), [772ST](#), [774](#) hoses.  
Dimensions and pressures are for reference only and are subject to change.



### 11671

SAE Code 61 Flange Head - 22-1/2° Elbow  
ISO 12151-3 - E22M - L

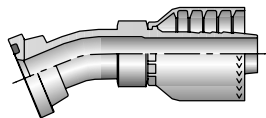

Part Number	Flange inch	Hose ID inch
11671-12-12	3/4	3/4
11671-16-12	1	3/4
11671-16-16	1	1
11671-20-16	1-1/4	1
11671-20-20	1-1/4	1-1/4
11671-24-20	1-1/2	1-1/4
11671-24-24	1-1/2	1-1/2
11671-32-32	2	2

### 11771

SAE Code 61 Flange Head - 45° Elbow  
ISO 12151-3 - E45S - L  
(1 Piece: ISO 12151-3 - E45M - L)

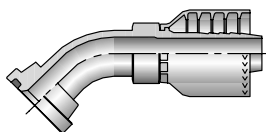

Part Number	Flange inch	Hose ID inch
11771-10-10	5/8	5/8
11771-12-8	3/4	1/2
11771-12-10	3/4	5/8
11771-12-12	3/4	3/4
11771-16-12	1	3/4
11771-16-16	1	1
11771-20-16	1-1/4	1
11771-20-20	1-1/4	1-1/4
11771-20-24	1-1/4	1-1/2
11771-24-20	1-1/2	1-1/4
11771-24-24	1-1/2	1-1/2
11771-32-24	2	1-1/2
11771-32-32	2	2
11771-40-32	2-1/2	2

### 11871

SAE Code 61 Flange Head - 67-1/2° Elbow  
ISO 12151-3 - E67S - L  
(1 Piece: ISO 12151-3 - E67M - L)

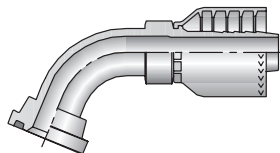

Part Number	Flange inch	Hose ID inch
11871-12-12	3/4	3/4
11871-16-12	1	3/4
11871-16-16	1	1
11871-20-20	1-1/4	1-1/4
11871-24-20	1-1/2	1-1/4
11871-24-24	1-1/2	1-1/2
11871-32-24	2	1-1/2
11871-32-32	2	2

### 11971

SAE Code 61 Flange Head - 90° Elbow  
ISO 12151-3 - E90S - L  
(1 Piece: ISO 12151-3 - E90M - L)

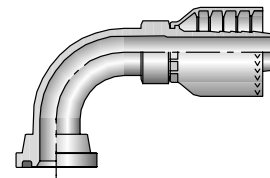

Part Number	Flange inch	Hose ID inch
11971-8-8	1/2	1/2
11971-10-10	5/8	5/8
11971-12-8	3/4	1/2
11971-12-10	3/4	5/8
11971-12-12	3/4	3/4
11971-16-12	1	3/4
11971-16-16	1	1
11971-16-20	1	1-1/4
11971-20-12	1-1/4	3/4
11971-20-16	1-1/4	1
11971-20-20	1-1/4	1-1/4
11971-20-24	1-1/4	1-1/2
11971-24-16	1-1/2	1
11971-24-20	1-1/2	1-1/4
11971-24-24	1-1/2	1-1/2
11971-32-24	2	1-1/2
11971-32-32	2	2
11971-40-32	2-1/2	2

### 12671

SAE Code 61 Flange Head - 30° Elbow  
ISO 12151-3 - E30S - L  
(1 Piece: ISO 12151-3 - E30M - L)

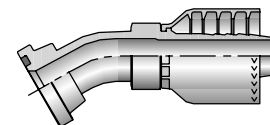

Part Number	Flange inch	Hose ID inch
12671-12-12	3/4	3/4
12671-16-16	1	1
12671-20-16	1-1/4	1
12671-20-20	1-1/4	1-1/4
12671-24-24	1-1/2	1-1/2
12671-32-24	2	1-1/2
12671-32-32	2	2

### 12771

SAE Code 61 Flange Head - 60° Elbow  
ISO 12151-3 - E60S - L  
(1 Piece: ISO 12151-3 - E60M - L)

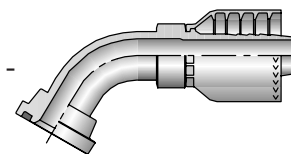

Part Number	Flange inch	Hose ID inch
12771-12-12	3/4	3/4
12771-16-12	1	3/4
12771-16-16	1	1
12771-20-20	1-1/4	1-1/4
12771-24-20	1-1/2	1-1/4
12771-24-24	1-1/2	1-1/2
12771-32-32	2	2

71 Series: Use with 711, 721, 721TC, 721ST, 722TC, 722ST, 774 hoses.  
Dimensions and pressures are for reference only and are subject to change.

### 12U71

SAE Code 61 Flange Head - 110° Elbow

Part Number	Flange inch	Hose ID inch
12U71-16-16	1	1

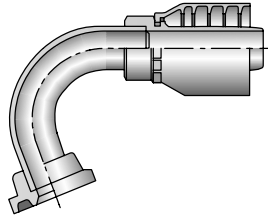

### 13771

Female JIC 37° - Swivel - 45° Elbow - Short Drop

Part Number	Thread inch	Hose ID inch
13771-6-6	3/8 9/16x18	3/8
13771-8-8	1/2 3/4x16	1/2
13771-10-8	5/8 7/8x14	1/2
13771-10-10	5/8 7/8x14	5/8
13771-12-12	3/4 1-1/16x12	3/4
13771-16-16	1 1-5/16x12	1
13771-20-20	1-1/4 1-5/8x12	1-1/4

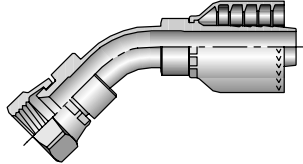

### 13971

Female JIC 37° - Swivel - 90° Elbow - Short Drop

Part Number	Thread inch	Hose ID inch
13971-6-6	3/8 9/16x18	3/8
13971-8-8	1/2 3/4x16	1/2
13971-10-8	5/8 7/8x14	1/2
13971-10-10	5/8 7/8x14	5/8
13971-12-10	3/4 1-1/16x12	5/8
13971-12-12	3/4 1-1/16x12	3/4
13971-16-16	1 1-5/16x12	1
13971-20-20	1-1/4 1-5/8x12	1-1/4
13971-24-24	1-1/2 1-7/8x12	1-1/2

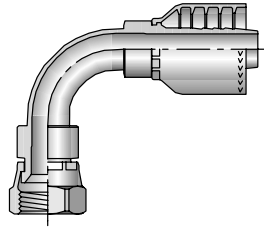

### 14171

Female JIC 37° - Swivel - 90° Elbow - Long Drop

Part Number	Thread inch	Hose ID inch
14171-6-6	3/8 9/16x18	3/8
14171-8-8	1/2 3/4x16	1/2
14171-12-12	3/4 1-1/16x14	3/4
14171-16-16	1 1-5/16x12	1

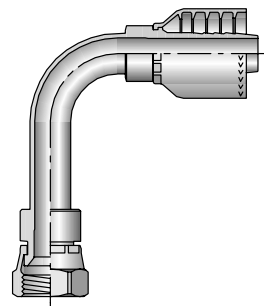

### 16A71

SAE Code 62 Flange Head ISO 12151-3 - S - S

Part Number	Flange inch	Hose ID inch
16A71-12-12	3/4	3/4
16A71-16-12	1	3/4
16A71-16-16	1	1
16A71-20-16	1-1/4	1
16A71-20-20	1-1/4	1-1/4
16A71-24-24	1-1/2	1-1/2
16A71-32-32	2	2

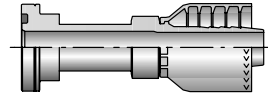

### 16F71

SAE Code 62 Flange Head - 45° Elbow

ISO 12151-3 - E45S - L  
(1 Piece: ISO 12151-3 - E45M - S)

Part Number	Flange inch	Hose ID inch
16F71-12-12	3/4	3/4
16F71-16-16	1	1
16F71-20-16	1-1/4	1
16F71-20-20	1-1/4	1-1/4
16F71-24-24	1-1/2	1-1/2
16F71-32-32	2	2

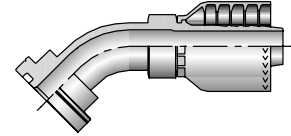

### 16N71

SAE Code 62 Flange Head - 90° Elbow

ISO 12151-3 - E90S - L  
(1 Piece: ISO 12151-3 - E90M - S)

Part Number	Flange inch	Hose ID inch
16N71-12-12	3/4	3/4
16N71-16-12	1	3/4
16N71-16-16	1	1
16N71-20-16	1-1/4	1
16N71-20-20	1-1/4	1-1/4
16N71-24-24	1-1/2	1-1/2
16N71-32-32	2	2

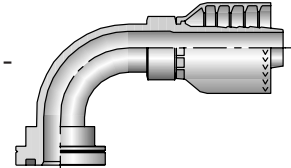

See [Section M](#) for O-Rings and Flange Kits.

⚠ Refer to [Section O](#) for Pressure Rating of Hose End Connections chart.

### 18971

SAE Code 61 Flange Head - 90° Elbow - Long Drop

Part Number	Flange inch	Hose ID inch
18971-12-12	3/4	3/4
18971-16-16	1	1
18971-20-16	1-1/4	1

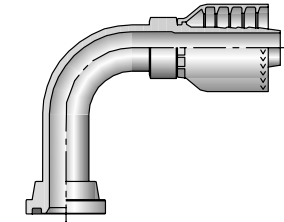

71 Series: Use with [711](#), [721](#), [721TC](#), [721ST](#), [722TC](#), [722TC](#), [722ST](#), [722ST](#), [774](#) hoses.  
Dimensions and pressures are for reference only and are subject to change.

### 1C971

Female Metric S - Swivel - (24° Cone with O-Ring)  
ISO 12151-2 - SWS - S

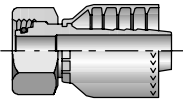

Part Number	Thread mm	Hose ID inch
1C971-12-6	12 M20x1,5	3/8
1C971-16-8	16 M24x1,5	1/2
1C971-20-10	20 M30x2	5/8
1C971-25-12	25 M36x2	3/4
1C971-30-16	30 M42x2	1
1C971-38-20	38 M52x2	1-1/4

Metric S: Mates with EO "S" Series Fittings.  
^^ Must be assembled with Die Part No. 83C-D20H in a Superkrimp or Parkrimp 2.

### 1D271

Male Metric S - Rigid - (24° Cone)  
ISO 12151-2

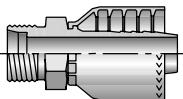

Part Number	Thread mm	Hose ID inch
1D271-25-12	25 M36x2	3/4
1D271-30-16	30 M42x2	1

Metric S: Mates with EO "S" Series Fittings.  
^^ Must be assembled with Die Part No. 83C-D20H in a Superkrimp or Parkrimp 2.

### 1FU71

Female BSP Parallel Pipe - Swivel - (30° Flare)

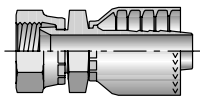

Part Number	Thread inch	Hose ID inch
1FU71-6-6	3/8x19	3/8
1FU71-8-8	1/2x14	1/2
1FU71-12-12	3/4x14	3/4
1FU71-16-16	1x11	1
1FU71-20-20	1-1/4x11	1-1/4
1FU71-24-24	1-1/2x11	1-1/2

### 1GU71

Female BSP Parallel Pipe - Swivel - (60° Cone)

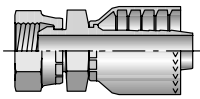

Part Number	Thread inch	Hose ID inch
1GU71-6-6	3/8 3/8x19	3/8
1GU71-8-8	1/2 1/2x14	1/2
1GU71-12-12	3/4 3/4x14	3/4
1GU71-16-16	1 1x11	1
1GU71-20-20	1-1/4 1-1/4x11	1-1/4
1GU71-24-24	1-1/2 1-1/2x11	1-1/2
1GU71-32-32	2 2x11	2

Metric S: Mates with EO "S" Series Fittings.  
^^ Must be assembled with Die Part No. 83C-D20H in a Superkrimp or Parkrimp 2.

### 1J071

Male Seal-Lok™ - Rigid - (with O-Ring)  
ISO 12151-1 - S

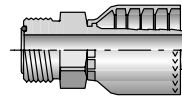

Part Number	Thread inch	Hose ID inch
1J071-8-8	1/2 13/16x16	1/2
1J071-10-8	5/8 1x14	1/2
1J071-10-10	5/8 1x14	5/8
1J071-12-10	3/4 1-3/16x12	5/8
1J071-12-12	3/4 1-3/16x12	3/4
1J071-16-12	1 1-7/16x12	3/4
1J071-16-16	1 1-7/16x12	1
1J071-20-20	1-1/4 1-11/16x12	1-1/4
1J071-24-24	1-1/2 2x12	1-1/2

### 1J171

Female Seal-Lok™ - Swivel - 90° Elbow - Long Drop  
ISO 12151-1 - SWEL90

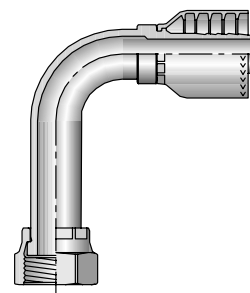

Part Number	Thread inch	Hose ID inch
1J171-6-6	3/8 11/16x16	3/8
1J171-8-8	1/2 13/16x16	1/2
1J171-10-10	5/8 1x14	5/8
1J171-12-12	3/4 1-3/16x12	3/4
1J171-16-12	1 1-7/16x12	3/4
1J171-16-16	1 1-7/16x12	1
1J171-20-20	1-1/4 1-11/16x12	1-1/4
1J171-24-24	1-1/2 2x12	1-1/2

### 1J571

Female Seal-Lok™ - Swivel - 90° Elbow - Medium Drop  
ISO 12151-1 - SWEM90

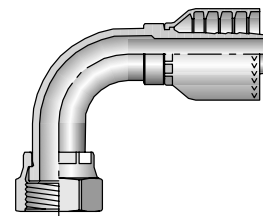

Part Number	Thread inch	Hose ID inch
1J571-8-8	1/2 13/16x16	1/2
1J571-10-10	5/8 1x14	5/8
1J571-12-12	3/4 1-3/16x12	3/4

71 Series: Use with 711, 721, 721TC, 721ST, 722TC, 722ST, 774 hoses.  
Dimensions and pressures are for reference only and are subject to change.

## 1J771

Female Seal-Lok™ - Swivel - 45° Elbow  
ISO 12151-1 - SWE45

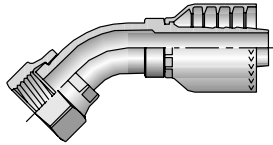

Part Number	Thread inch	Hose ID inch
1J771-6-6	3/8 11/16x16	3/8
1J771-8-8	1/2 13/16x16	1/2
1J771-10-8	5/8 1x14	1/2
1J771-10-10	5/8 1x14	5/8
1J771-12-12	3/4 1-3/16x12	3/4
1J771-16-16	1 1-7/16x12	1
1J771-20-20	1-1/4 1-11/16x12	1-1/4
1J771-24-24	1-1/2 2x12	1-1/2

## 1J971

Female Seal-Lok™ - Swivel - 90° Elbow - Short Drop  
ISO 12151-1 - SWES90

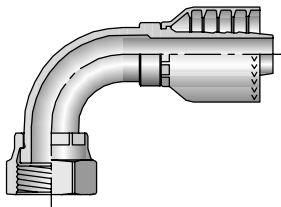

Part Number	Thread inch	Hose ID inch
1J971-6-6	3/8 11/16x16	3/8
1J971-8-8	1/2 13/16x16	1/2
1J971-10-8	5/8 1x14	1/2
1J971-10-10	5/8 1x14	5/8
1J971-10-12	5/8 1x14	3/4
1J971-12-10	3/4 1-3/16x12	5/8
1J971-12-12	3/4 1-3/16x12	3/4
1J971-16-16	1 1-7/16x12	1
1J971-20-20	1-1/4 1-11/16x12	1-1/4
1J971-24-24	1-1/2 2x12	1-1/2

## 1JC71

Female Seal-Lok™ - Swivel - Short  
ISO 12151-1 - SWSA

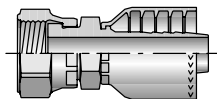

Part Number	Thread inch	Hose ID inch
1JC71-8-8	1/2 13/16x16	1/2
1JC71-10-10	5/8 1x14	5/8
1JC71-12-12	3/4 1-3/16x12	3/4
1JC71-16-16	1 1-7/16x12	1
1JC71-20-16	1-1/4 1-11/16x12	1

## 1JS71

Female Seal-Lok™ - Swivel - Long  
ISO 12151-1 - SWSB

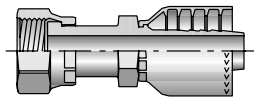

Part Number	Thread inch	Hose ID inch
1JS71-6-6	3/8 11/16x16	3/8
1JS71-6-8	3/8 11/16x16	1/2
1JS71-8-8	1/2 13/16x16	1/2
1JS71-10-8	5/8 1x14	1/2
1JS71-10-10	5/8 1x14	5/8
1JS71-10-12	5/8 1x14	3/4
1JS71-12-10	3/4 1-3/16x12	5/8
1JS71-12-12	3/4 1-3/16x12	3/4
1JS71-16-12	1 1-7/16x12	3/4
1JS71-16-16	1 1-7/16x12	1
1JS71-20-16	1-1/4 1-11/16x12	1
1JS71-20-20	1-1/4 1-11/16x12	1-1/4
1JS71-24-24	1-1/2 2x12	1-1/2

## 1L971

Female JIC 37° - Swivel - 90° Elbow - Medium Drop

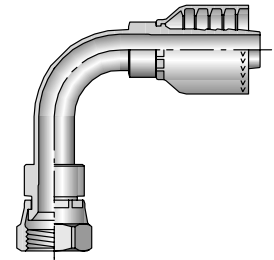

Part Number	Thread inch	Hose ID inch
1L971-10-8	5/8 7/8x14	1/2

## 1MU71

Female Metric - Swivel - (30° Flare)

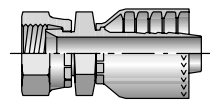

Part Number	Thread inch	Hose ID inch
1MU71-6-6	M18x1,5	3/8
1MU71-8-8	M22x1,5	1/2

Japanese Fittings - Female Swivel 30° Flare with Metric Threads. All 30° flared fitting sizes are available by combining 1MU71 fittings in sizes up to 1/2 with 1XU71 fittings in sizes 5/8 inch and larger.

## 1UT71

Male BSP Taper Pipe - Rigid - (60° Cone)

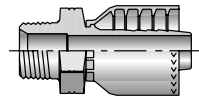

Part Number	Hose ID inch
1UT71-8-8	1/2
1UT71-12-12	3/4

71 Series: Use with 711, 721, 721TC, 721ST, 722TC, 772TC, 772ST, 774 hoses.  
Dimensions and pressures are for reference only and are subject to change.

## 1XU71

Female Metric - Swivel - (30° Flare)

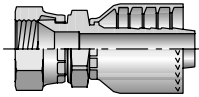

Part Number	Thread mm	Hose ID inch
1XU71-10-10	M24x1,5	5/8
1XU71-12-12	M30x1,5	3/4
1XU71-16-16	M33x1,5	1
1XU71-20-20	M36x1,5	1-1/4
1XU71-24-24	M42x1,5	1-1/2

Japanese Fittings - Female Swivel 30° Flare with Metric Threads. All 30° flared fitting sizes are available by combining 1MU71 fittings in sizes up to 1/2 with 1XU71 fittings in sizes 5/8 inch and larger.

## 10577

Male SAE Straight Thread with O-Ring - Rigid - Straight

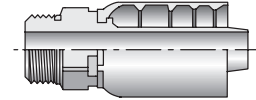

Part Number	Thread inch	Hose ID inch
10577-8-8	1/2	3/4x16
10577-12-12	3/4	1-1/16x12
10577-16-16	1	1-5/16x12
10577-20-20	1-1/4	1-5/8x12

## 10677

Female JIC 37° - Swivel - Straight

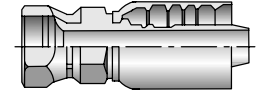

Part Number	Thread inch	Hose ID inch
10677-8-8	1/2	3/4x16
10677-10-8	5/8	7/8x14
10677-10-10	5/8	7/8x14
10677-10-12	5/8	7/8x14
10677-12-8	3/4	1-1/16x12
10677-12-10	3/4	1-1/16x12
10677-12-12	3/4	1-1/16x12
10677-12-16	3/4	1-1/16x12
10677-14-12	7/8	1-3/16x12
10677-16-12	1	1-5/16x12
10677-16-16	1	1-5/16x12
10677-20-16	1-1/4	1-5/8x12
10677-20-20	1-1/4	1-5/8x12
10677-24-20	1-1/2	1-7/8x12
10677-24-24	1-1/2	1-7/8x12
10677-32-32	2	2-1/2x12

All sizes of 10677 fittings are rated at 5,000 psi working pressure.

## 77 Series

### 10177

Male NPTF Pipe - Rigid - Straight

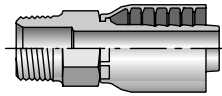

Part Number	Thread inch	Hose ID inch
10177-8-8	1/2x14	1/2
10177-8-12	1/2x14	3/4
10177-12-12	3/4x14	3/4
10177-16-16	1x11-1/2	1
10177-20-20	1-1/4x11-1/2	1-1/4
10177-24-24	1-1/2x11-1/2	1-1/2
10177-32-32	2x11-1/2	2

All sizes of 10177 fittings are rated at 5,000 psi working pressure.

Refer to [Section O](#) for Pressure Rating of Hose End Connections chart.

### 10C77

Female Metric S - Swivel - 45° Elbow - (24° Cone with O-Ring) ISO 12151-2-SWE-45

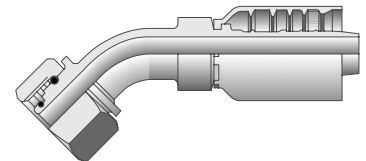

Part Number	Thread mm	Hose ID inch
10C77-16-8	16 M24x1,5	1/2
10C77-20-10	20 M30x2	5/8
10C77-20-12	20 M30x2	3/4
10C77-25-12	25 M36x2	3/4
10C77-30-16	30 M42x2	1
10C77-38-20	38 M52x2	1-1/4
10C77-38-24	38 M52x2	1-1/2

### 10377

Male JIC 37° - Rigid - Straight

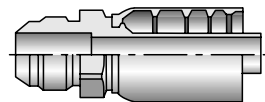

Part Number	Thread inch	Hose ID inch
10377-8-8	1/2	3/4x16
10377-10-8	5/8	7/8x14
10377-10-10	5/8	7/8x14
10377-12-10	3/4	1-1/16x12
10377-12-12	3/4	1-1/16x12
10377-16-12	1	1-5/16x12
10377-16-16	1	1-5/16x12
10377-20-16	1-1/4	1-5/8x12
10377-20-20	1-1/4	1-5/8x12
10377-32-32	2	2-1/2x12

All sizes of 10377 are rated at 5,000 psi working pressure.

Refer to [Section O](#) for Pressure Rating of Hose End Connections chart.

71 Series: Use with [711](#), [721](#), [721TC](#), [721ST](#), [722TC](#), [722TC](#), [722ST](#), [774](#) hoses. Dimensions and pressures are for reference only and are subject to change.

### 11577

SAE Code 61 Flange Head  
ISO 12151-3-S-L

Part Number	Flange inch	Hose ID inch
11577-8-8	1/2	1/2
11577-10-10	5/8	5/8
11577-12-8	3/4	1/2
11577-12-10	3/4	5/8
11577-12-12	3/4	3/4
11577-16-12	1	3/4
11577-16-16	1	1
11577-32-32	2	2

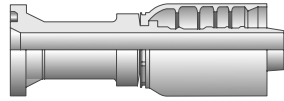

### 11977

SAE Code 61 Flange Head - 90° Elbow  
ISO 12151-3-E90M-L

Part Number	Flange inch	Hose ID inch
11977-8-8	1/2	1/2
11977-12-8	3/4	1/2
11977-12-12	3/4	3/4
11977-16-10	1	5/8
11977-16-12	1	3/4
11977-16-16	1	1
11977-20-20	1-1/4	1-1/4
11977-24-24	1-1/2	1-1/2
11977-32-32	2	2

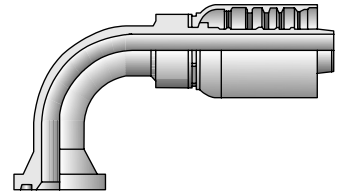

### 11677

SAE Code 61 Flange Head - 22-1/2° Elbow  
ISO 12151-3-E22M-L

Part Number	Flange inch	Hose ID inch
11677-16-16	1	1
11677-20-20	1-1/4	1-1/4
11677-24-24	1-1/2	1-1/2
11677-32-32	2	2

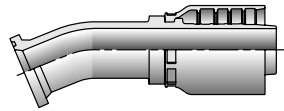

### 11C77

Female Metric S - Swivel - 90° Elbow - (24° Cone with O-Ring)  
ISO 12151-2-SWE

Part Number	Thread mm	Hose ID inch
11C77-16-8	M24x1,5	1/2
11C77-20-10	M30x2	5/8
11C77-20-12	M30x2	3/4
11C77-25-12	M36x2	3/4
11C77-25-16	M36x2	1
11C77-30-16	M42x2	1
11C77-38-20	M52x2	1-1/4
11C77-38-24	M52x2	1-1/2

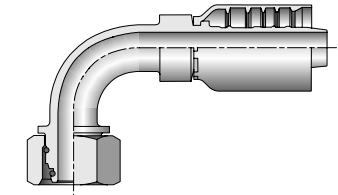

### 11777

SAE Code 61 Flange Head - 45° Elbow  
ISO 12151-3-E45M-L

Part Number	Flange inch	Hose ID inch
11777-8-8	1/2	1/2
11777-12-12	3/4	3/4
11777-16-12	1	3/4
11777-16-16	1	1
11777-32-32	2	2

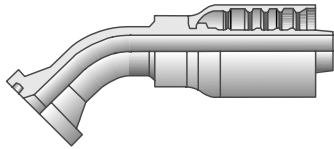

### 12677

SAE Code 61 Flange Head - 30° Elbow  
ISO 12151-3-E30M-L

Part Number	Flange inch	Hose ID inch
12677-16-16	1	1
12677-20-20	1-1/4	1-1/4
12677-32-32	2	2

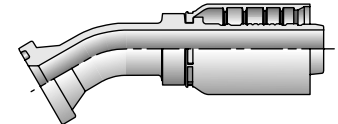

### 11877

SAE Code 61 Flange Head - 67-1/2° Elbow  
ISO 12151-3-E67M-L

Part Number	Flange inch	Hose ID inch
11877-16-16	1	1
11877-32-32	2	2

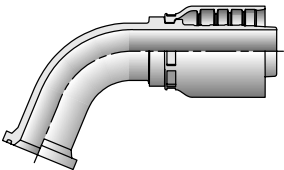

### 12777

SAE Code 61 Flange Head - 60° Elbow  
ISO 12151-3-E60M-L

Part Number	Flange inch	Hose ID inch
12777-12-12	3/4	3/4
12777-16-12	1	3/4
12777-16-16	1	1
12777-32-32	2	2

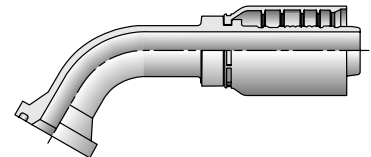

77 Series: Use with [787TC](#), [797TC](#) hoses.

Dimensions and pressures are for reference only and are subject to change.

### 13777

Female JIC 37° - Swivel - 45° Elbow - Short Drop

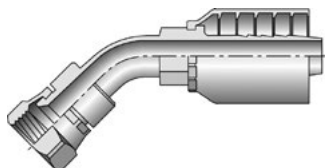

Part Number	Thread inch	Hose ID inch
13777-8-8	1/2 3/4x16	1/2
13777-10-8	5/8 7/8x14	1/2
13777-10-10	5/8 7/8x14	5/8
13777-12-12	3/4 1-1/16x12	3/4
13777-16-12	1 1-5/16x12	3/4
13777-16-16	1 1-5/16x12	1
13777-20-20	1-1/4 1-5/8x12	1-1/4

All sizes of 13777 fittings are rated at 5,000 psi working pressure.

### 13977

Female JIC 37° - Swivel - 90° Elbow - Short Drop

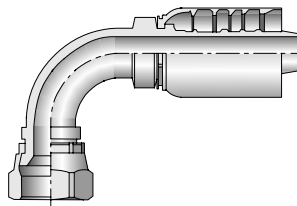

Part Number	Thread inch	Hose ID inch
13977-8-8	1/2 3/4x16	1/2
13977-10-8	5/8 7/8x14	1/2
13977-10-10	5/8 7/8x14	5/8
13977-12-10	3/4 1-1/16x12	5/8
13977-12-12	3/4 1-1/16x12	3/4
13977-16-12	1 1-5/16x12	3/4
13977-16-16	1 1-5/16x12	1
13977-20-20	1-1/4 1-5/8x12	1-1/4
13977-24-24	1-1/2 1-7/8x12	1-1/2
13977-32-32	2 2-1/2x12	2

All sizes of 13977 fittings are rated at 5,000 psi working pressure.

### 14177

Female JIC 37° - Swivel - 90° Elbow - Long Drop  
ISO 12151-5

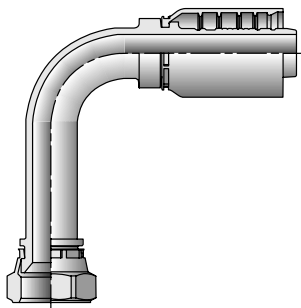

Part Number	Thread inch	Hose ID inch
14177-8-8	1/2 3/4x16	1/2
14177-12-12	3/4 1-1/16x12	3/4
14177-16-16	1 1-5/16x12	1

All sizes of 14177 fittings are rated at 5,000 psi working pressure.

### 14A77

SAE Code 61 Flange Head - Straight  
ISO 12151-3-S-L

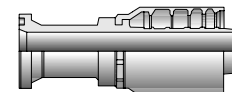

Part Number	Flange inch	Hose ID inch
14A77-20-16	1-1/4	1
14A77-20-20	1-1/4	1-1/4
14A77-24-20	1-1/2	1-1/4
14A77-24-24	1-1/2	1-1/2
14A77-32-24	2	1-1/2
14A77-32-32	2	2

### 14B77

SAE Code 61 Flange Head - 22-1/2° Elbow  
ISO 12151-3-E22M-L (5000 psi)

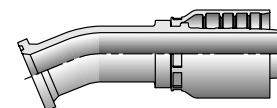

Part Number	Flange inch	Hose ID inch
14B77-20-20	1-1/4	1-1/4
14B77-24-24	1-1/2	1-1/2
14B77-32-32	2	2

### 14F77

SAE Code 61 5000 psi Flange Head - 45°  
ISO 12151-3-E45M-L

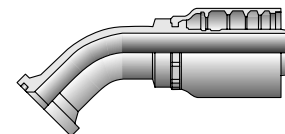

Part Number	Flange inch	Hose ID inch
14F77-20-16	1-1/4	1
14F77-20-20	1-1/4	1-1/4
14F77-24-20	1-1/2	1-1/4
14F77-24-24	1-1/2	1-1/2
14F77-32-24	2	1-1/2
14F77-32-32	2	2

### 14G77

SAE Code 61 Flange Head - 60° Elbow  
ISO 12151-3-E60M-L

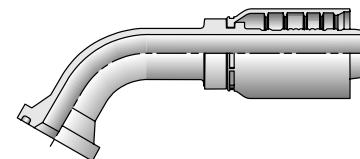

Part Number	Flange inch	Hose ID inch
14G77-20-16	1-1/4	1
14G77-32-32	2	2

77 Series: Use with [787TC](#), [797TC](#) hoses.

Dimensions and pressures are for reference only and are subject to change.

### 14N77

SAE Code 61 Flange Head - 90°  
ISO 12151-3-E90M-L

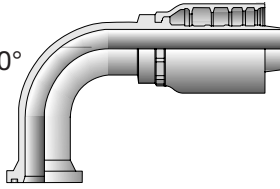

Part Number	Flange inch	Hose ID inch
14N77-20-16	1-1/4	1
14N77-20-20	1-1/4	1-1/4
14N77-24-20	1-1/2	1-1/4
14N77-24-24	1-1/2	1-1/2
14N77-32-24	2	1-1/2
14N77-32-32	2	2

### 16A77

SAE Code 62 Flange Head - Straight  
ISO 12151-3-S-S

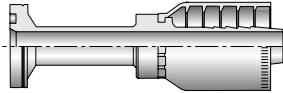

Part Number	Flange inch	Hose ID inch
16A77-8-8	1/2	1/2
16A77-12-10	3/4	5/8
16A77-12-12	3/4	3/4
16A77-12-16	3/4	1
16A77-16-12	1	3/4
16A77-16-16	1	1
16A77-16-20	1	1-1/4
16A77-20-16	1-1/4	1
16A77-20-20	1-1/4	1-1/4
16A77-20-24	1-1/4	1-1/2
16A77-24-16	1-1/2	1
16A77-24-20	1-1/2	1-1/4
16A77-24-24	1-1/2	1-1/2
16A77-32-24	2	1-1/2
16A77-32-32	2	2

### 16B77

SAE Code 62 Flange Head - 22-1/2° Elbow  
ISO 12151-3-E22M-S

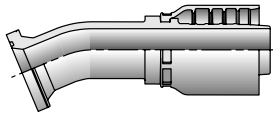

Part Number	Flange inch	Hose ID inch
16B77-12-12	3/4	3/4
16B77-16-12	1	3/4
16B77-16-16	1	1
16B77-20-20	1-1/4	1-1/4
16B77-24-24	1-1/2	1-1/2
16B77-32-32	2	2

### 16E77

SAE Code 62 Flange Head - 30° Elbow  
ISO 12151-3-E30M-S

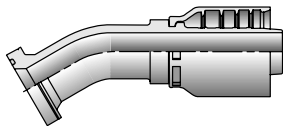

Part Number	Flange inch	Hose ID inch
16E77-12-12	3/4	3/4
16E77-16-16	1	1
16E77-20-20	1-1/4	1-1/4
16E77-24-24	1-1/2	1-1/2
16E77-32-32	2	2

### 16F77

SAE Code 62 Flange Head - 45° Elbow  
ISO 12151-3-E45M-S

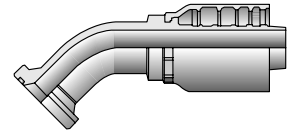

Part Number	Flange inch	Hose ID inch
16F77-8-8	1/2	1/2
16F77-12-10	3/4	5/8
16F77-12-12	3/4	3/4
16F77-12-16	3/4	1
16F77-16-12	1	3/4
16F77-16-16	1	1
16F77-16-20	1	1-1/4
16F77-20-16	1-1/4	1
16F77-20-20	1-1/4	1-1/4
16F77-20-24	1-1/4	1-1/2
16F77-24-20	1-1/2	1-1/4
16F77-24-24	1-1/2	1-1/2
16F77-32-32	2	2

### 16G77

SAE Code 62 Flange Head - 60° Elbow  
ISO 12151-3-E60M-S

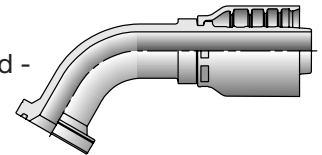

Part Number	Flange inch	Hose ID inch
16G77-12-12	3/4	3/4
16G77-16-16	1	1
16G77-20-20	1-1/4	1-1/4
16G77-24-24	1-1/2	1-1/2
16G77-32-32	2	2

### 16N77

SAE Code 62 Flange Head - 90° Elbow  
ISO 12151-3 - E90M - S

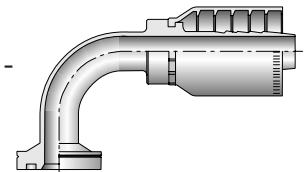

Part Number	Flange inch	Hose ID inch
16N77-8-8	1/2	1/2
16N77-8-10	1/2	5/8
16N77-12-10	3/4	5/8
16N77-12-12	3/4	3/4
16N77-12-16	3/4	1
16N77-16-12	1	3/4
16N77-16-16	1	1
16N77-16-20	1	1-1/4
16N77-20-16	1-1/4	1
16N77-20-20	1-1/4	1-1/4
16N77-20-24	1-1/4	1-1/2
16N77-24-20	1-1/2	1-1/4
16N77-24-24	1-1/2	1-1/2
16N77-32-24	2	1-1/2
16N77-32-32	2	2

77 Series: Use with [787TC](#), [797TC](#) hoses.

Dimensions and pressures are for reference only and are subject to change.



### 1AP77

Male API Pipe - Rigid - Straight

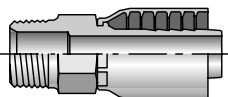

Part Number	Thread inch	Hose ID inch
1AP77-24-24	1-1/2x11-1/2	1-1/2
1AP77-32-32	2x11-1/2	2

### 1C977

Female Metric S - Swivel - Straight (24° Cone with O-Ring)  
ISO 12151-2-SWS

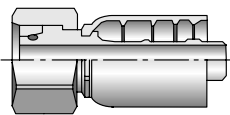

Part Number	Thread mm	Hose ID inch
1C977-16-8	16 M24x1,5	1/2
1C977-16-10	16 M24x1,5	5/8
1C977-20-10	20 M30x2	5/8
1C977-20-12	20 M30x2	3/4
1C977-25-12	25 M36x2	3/4
1C977-25-16	25 M36x2	1
1C977-30-12	30 M42x2	3/4
1C977-30-16	30 M42x2	1
1C977-30-20	30 M42x2	1-1/4
1C977-38-20	38 M52x2	1-1/4
1C977-38-24	38 M52x2	1-1/2

### 1D277

Male Metric S - Rigid - (24° Cone)  
End Connection per ISO 8434-1-BHS

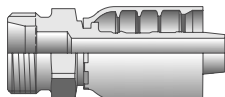

Part Number	Thread mm	Hose ID inch
1D277-16-8	M24x1,5	1/2
1D277-20-10	M30x2	5/8
1D277-20-12	M30x2	3/4
1D277-25-12	M36x2	3/4
1D277-25-16	M36x2	1
1D277-30-16	M42x2	1
1D277-38-20	M52x2	1-1/4
1D277-38-24	M52x2	1-1/2

### 1FU77

Female BSP Parallel Pipe - Swivel - (30° Flare)  
B8363 Code F

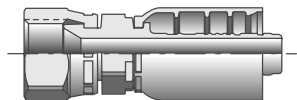

Part Number	Thread mm	Hose ID inch
1FU77-8-8	1/2x14	1/2
1FU77-12-12	3/4x14	3/4
1FU77-16-16	1x11	1
1FU77-20-20	1-1/4x11	1-1/4

### 1GU77

Female BSP Parallel Pipe - Swivel - Straight (60° Cone)

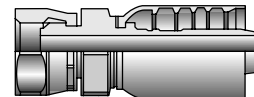

Part Number	Thread inch	Hose ID inch
1GU77-8-8	1/2x14	1/2
1GU77-12-12	3/4x14	3/4
1GU77-16-16	1x11	1
1GU77-20-20	1-1/4x11	1-1/4

### 1J077

Male Seal-Lok™ - Rigid - Straight - (with O-Ring)  
ISO 12151-1-S

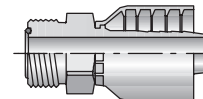

Part Number	Thread inch	Hose ID inch
1J077-8-8	13/16x16	1/2
1J077-10-8	1x14	1/2
1J077-10-10	1x14	5/8
1J077-12-10	1-3/16x12	5/8
1J077-12-12	1-3/16x12	3/4
1J077-16-12	1-7/16x12	3/4
1J077-16-16	1-7/16x12	1
1J077-20-16	1-11/16x12	1
1J077-20-20	1-11/16x12	1-1/4
1J077-24-20	2x12	1-1/4

⚠ Refer to [Section O](#) for Pressure Rating of Hose End Connections chart.

### 1J177

Female Seal-Lok™ - Swivel - 90° Elbow - Long Drop  
ISO 12151-1-SWEL90

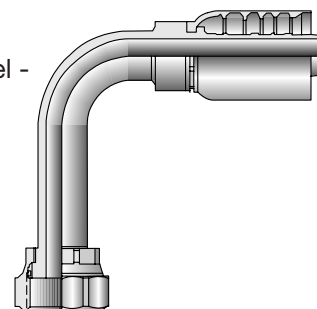

Part Number	Thread inch	Hose ID inch
1J177-8-8	13/16x16	1/2
1J177-10-10	1x14	5/8
1J177-12-10	1-3/16x12	5/8
1J177-12-12	1-3/16x12	3/4
1J177-16-12	1-7/16x12	3/4
1J177-16-16	1-7/16x12	1
1J177-20-16	1-11/16x12	1
1J177-20-20	1-11/16x12	1-1/4

⚠ Refer to [Section O](#) for Pressure Rating of Hose End Connections chart.

77 Series: Use with [787TC](#), [797TC](#) hoses.

Dimensions and pressures are for reference only and are subject to change.

### 1J577

Female Seal-Lok™ - Swivel - 90° Elbow - Medium Drop  
ISO 12151-1 - SWEM90

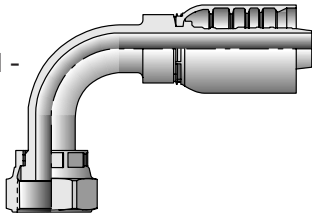

Part Number	Thread inch	Hose ID inch
1J577-8-8	1/2 13/16x16	1/2
1J577-10-10	5/8 1x14	5/8
1J577-12-12	3/4 1-3/16x12	3/4
1J577-16-12	1 1-7/16x12	3/4
1J577-16-16	1 1-7/16x12	1
1J577-20-20	1-1/4 1-11/16x12	1-1/4

⚠ Refer to [Section O](#) for Pressure Rating of Hose End Connections chart.

### 1J777

Female Seal-Lok™ - Swivel - 45° Elbow  
ISO 12151-1-SWE45

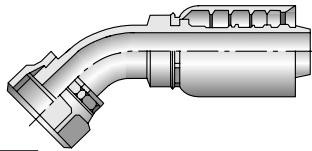

Part Number	Thread inch	Hose ID inch
1J777-8-8	1/2 13/16x16	1/2
1J777-10-8	5/8 1x14	1/2
1J777-10-10	5/8 1x14	5/8
1J777-12-12	3/4 1-3/16x12	3/4
1J777-16-16	1 1-7/16x12	1
1J777-20-20	1-1/4 1-11/16x12	1-1/4
1J777-24-20	1-1/2 2x12	1-1/4
1J777-24-24	1-1/2 2x12	1-1/2

⚠ Refer to [Section O](#) for Pressure Rating of Hose End Connections chart.

### 1J977

Female Seal-Lok™ - Swivel - 90° Elbow - Short Drop  
ISO 12151-1-SWES90

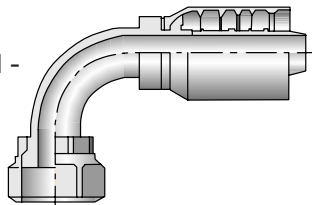

Part Number	Thread inch	Hose ID inch
1J977-8-8	1/2 13/16x16	1/2
1J977-10-8	5/8 1x14	1/2
1J977-10-10	5/8 1x14	5/8
1J977-12-8	3/4 1-3/16x12	1/2
1J977-12-10	3/4 1-3/16x12	5/8
1J977-12-12	3/4 1-3/16x12	3/4
1J977-16-12	1 1-7/16x12	3/4
1J977-16-16	1 1-7/16x12	1
1J977-16-20	1 1-7/16x12	1-1/4
1J977-20-16	1-1/4 1-11/16x12	1
1J977-20-20	1-1/4 1-11/16x12	1-1/4
1J977-24-24	1-1/2 2x12	1-1/2

⚠ Refer to [Section O](#) for Pressure Rating of Hose End Connections chart.

### 1JC77

Female Seal-Lok™ - Swivel - Straight - Short  
ISO 12151-1-SWSA

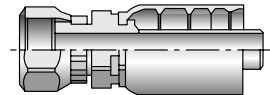

Part Number	Thread inch	Hose ID inch
1JC77-8-8	1/2 13/16x16	1/2
1JC77-10-10	5/8 1x14	5/8
1JC77-12-12	3/4 1-3/16x12	3/4
1JC77-16-12	1 1-7/16x12	3/4
1JC77-16-16	1 1-7/16x12	1
1JC77-20-16	1-1/4 1-11/16x12	1
1JC77-32-32	2 2-1/2x12	2

### 1JS77

Female Seal-Lok™ - Swivel - Straight - Long  
ISO 12151-1-SWSB

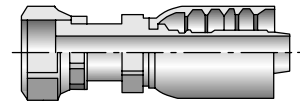

Part Number	Thread inch	Hose ID inch
1JS77-6-8	3/8 11/16x16	1/2
1JS77-8-8	1/2 13/16x16	1/2
1JS77-10-8	5/8 1x14	1/2
1JS77-10-10	5/8 1x14	5/8
1JS77-12-8	3/4 1-3/16x12	1/2
1JS77-12-10	3/4 1-3/16x12	5/8
1JS77-12-12	3/4 1-3/16x12	3/4
1JS77-12-16	3/4 1-3/16x12	1
1JS77-16-12	1 1-7/16x12	3/4
1JS77-16-16	1 1-7/16x12	1
1JS77-16-20	1 1-7/16x12	1-1/4
1JS77-20-16	1-1/4 1-11/16x12	1
1JS77-20-20	1-1/4 1-11/16x12	1-1/4
1JS77-24-24	1-1/2 2x12	1-1/2
1JS77-32-32	2 2-1/2x12	2

⚠ Refer to [Section O](#) for Pressure Rating of Hose End Connections chart.

-32 size rated to 3,000 psi.

### 1K577

Komatsu® Flange Head - Straight

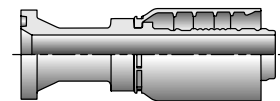

Part Number	Flange inch	Hose ID inch
1K577-16-16	1	1

### 1K777

Komatsu® Flange Head - 45° Elbow

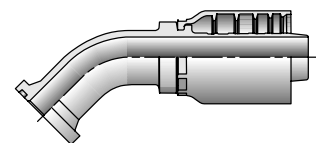

Part Number	Flange inch	Hose ID inch
1K777-12-12	3/4	3/4
1K777-16-16	1	1
1K777-20-20	1-1/4	1-1/4

77 Series: Use with 787TC, 797TC hoses.

Dimensions and pressures are for reference only and are subject to change.

### 1K977

Komatsu® Flange Head - 90° Elbow

Part Number	Flange inch	Hose ID inch
1K977-12-12	3/4	3/4
1K977-16-16	1	1
1K977-20-20	1-1/4	1-1/4

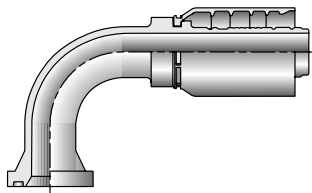

### 1X577

Full Flange - Straight - Code 61/62

Part Number	Flange inch	Hose ID inch
1X577-8-8	1/2	1/2
1X577-12-12	3/4	3/4
1X577-16-12	1	3/4
1X577-16-16	1	1
1X577-16-20	1	1-1/4
1X577-20-16	1-1/4	1
1X577-20-20	1-1/4	1-1/4
1X577-24-20	1-1/2	1-1/4
1X577-24-24	1-1/2	1-1/2

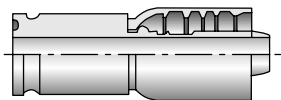

### 1X777

Full Flange - 45° Elbow - Code 61/62

Part Number	Flange inch	Hose ID inch
1X777-12-12	3/4	3/4
1X777-16-12	1	3/4
1X777-16-16	1	1
1X777-16-20	1	1-1/4
1X777-20-16	1-1/4	1
1X777-20-20	1-1/4	1-1/4
1X777-24-20	1-1/2	1-1/4
1X777-24-24	1-1/2	1-1/2

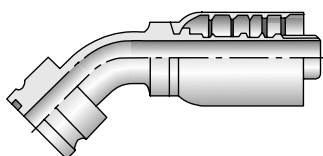

### 1X977

Full Flange - 90° Elbow - Code 61/62

Part Number	Flange inch	Hose ID inch
1X977-8-8	1/2	1/2
1X977-12-12	3/4	3/4
1X977-12-16	3/4	1
1X977-16-12	1	3/4
1X977-16-16	1	1
1X977-16-20	1	1-1/4
1X977-20-16	1-1/4	1
1X977-20-20	1-1/4	1-1/4
1X977-24-20	1-1/2	1-1/4
1X977-24-24	1-1/2	1-1/2

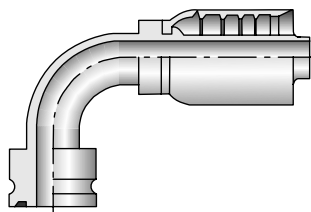

### 1XA77

Caterpillar® Flange Head - Straight

Part Number	Flange inch	Hose ID inch
1XA77-12-12	3/4	3/4
1XA77-12-16	3/4	1
1XA77-16-12	1	3/4
1XA77-16-16	1	1
1XA77-20-16	1-1/4	1
1XA77-20-20	1-1/4	1-1/4
1XA77-20-24	1-1/4	1-1/2
1XA77-24-20	1-1/2	1-1/4
1XA77-24-24	1-1/2	1-1/2
1XA77-32-24	2	1-1/2
1XA77-32-32	2	2

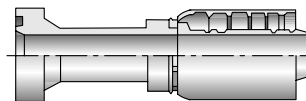

### 1XB77

Caterpillar® Flange Head - 22-1/2° Elbow

Part Number	Flange inch	Hose ID inch
1XB77-12-12	3/4	3/4
1XB77-16-12	1	3/4
1XB77-16-16	1	1
1XB77-20-16	1-1/4	1
1XB77-20-20	1-1/4	1-1/4
1XB77-24-20	1-1/2	1-1/4
1XB77-24-24	1-1/2	1-1/2

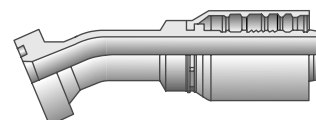

### 1XE77

Caterpillar® Flange Head - 30° Elbow

Part Number	Flange inch	Hose ID inch
1XE77-12-12	3/4	3/4
1XE77-16-12	1	3/4
1XE77-16-16	1	1
1XE77-20-16	1-1/4	1
1XE77-20-20	1-1/4	1-1/4
1XE77-24-20	1-1/2	1-1/4
1XE77-24-24	1-1/2	1-1/2

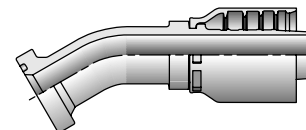

### 1XF77

Caterpillar® Flange Head - 45° Elbow

Part Number	Flange inch	Hose ID inch
1XF77-12-12	3/4	3/4
1XF77-16-12	1	3/4
1XF77-16-16	1	1
1XF77-20-16	1-1/4	1
1XF77-20-20	1-1/4	1-1/4
1XF77-24-20	1-1/2	1-1/4
1XF77-24-24	1-1/2	1-1/2

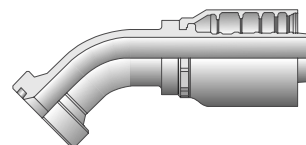

77 Series: Use with [787TC](#), [797TC](#) hoses.

Dimensions and pressures are for reference only and are subject to change.

### 1XG77

Caterpillar® Flange Head - 60° Elbow

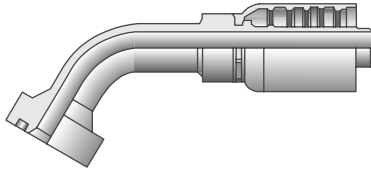

Part Number	Flange inch	Hose ID inch
1XG77-12-12	3/4	3/4
1XG77-16-12	1	3/4
1XG77-16-16	1	1
1XG77-20-16	1-1/4	1
1XG77-20-20	1-1/4	1-1/4
1XG77-24-20	1-1/2	1-1/4
1XG77-24-24	1-1/2	1-1/2

### 1XM77

Caterpillar® Flange - 67-1/2° Elbow

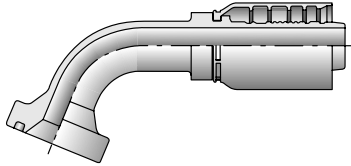

Part Number	Flange inch	Hose ID inch
1XM77-12-12	3/4	3/4
1XM77-16-12	1	3/4
1XM77-16-16	1	1
1XM77-20-16	1-1/4	1
1XM77-20-20	1-1/4	1-1/4
1XM77-24-20	1-1/2	1-1/4

### 1XN77

Caterpillar® Flange Head - 90° Elbow

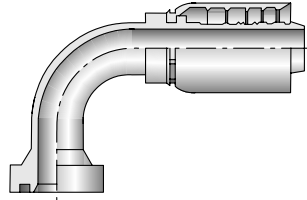

Part Number	Flange inch	Hose ID inch
1XN77-12-12	3/4	3/4
1XN77-16-12	1	3/4
1XN77-16-16	1	1
1XN77-20-16	1-1/4	1
1XN77-20-20	1-1/4	1-1/4
1XN77-20-24	1-1/4	1-1/2
1XN77-24-20	1-1/2	1-1/4
1XN77-24-24	1-1/2	1-1/2
1XN77-32-24	2	1-1/2

### 1ZM77

Male 24° Cone Metric - Rigid - Straight

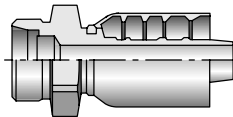

Part Number	Thread mm	Hose ID inch
1ZM77-22-10	M30x1,5	5/8
1ZM77-22-12	M30x1,5	3/4
1ZM77-28-12	M36x1,5	3/4
1ZM77-28-16	M36x1,5	1
1ZM77-35-16	M45x1,5	1

## 79 Series

### 16A79

SAE Code 62 Flange Head  
ISO 12151-3 - S - S

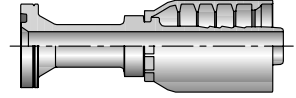

Part Number	Flange inch	Hose ID inch
16A79-12-12	3/4	3/4
16A79-16-12	1	3/4
16A79-16-16	1	1
16A79-20-16	1-1/4	1
16A79-20-20	1-1/4	1-1/4
16A79-24-24	1-1/2	1-1/2

### 16F79

SAE Code 62 Flange Head -  
45° Elbow  
ISO 12151-3 - E45S - S  
(1 Piece: ISO 12151-3 - E45M - S)

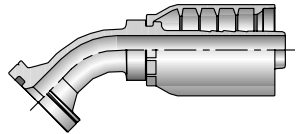

Part Number	Flange inch	Hose ID inch
16F79-12-12	3/4	3/4
16F79-16-16	1	1
16F79-16-20	1	1-1/4
16F79-20-16	1-1/4	1
16F79-20-20	1-1/4	1-1/4
16F79-24-24	1-1/2	1-1/2

### 16G79

SAE Code 62 Flange Head -  
60° Elbow  
ISO 12151-3 - E60S - S  
(1 Piece: ISO 12151-3 - E60M - S)

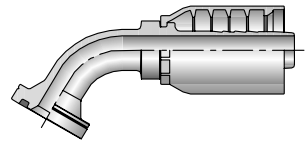

Part Number	Flange inch	Hose ID inch
16G79-16-16	1	1

### 16N79

SAE Code 62 Flange Head -  
90° Elbow  
ISO 12151-3 - E90S - S  
(1 Piece: ISO 12151-3 - E90M - S)

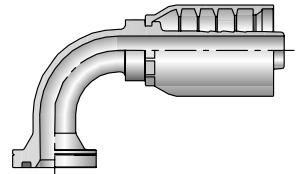

Part Number	Flange inch	Hose ID inch
16N79-12-12	3/4	3/4
16N79-16-12	1	3/4
16N79-16-16	1	1
16N79-20-16	1-1/4	1
16N79-20-20	1-1/4	1-1/4
16N79-24-24	1-1/2	1-1/2

77 Series: Use with 787TC, 797TC hoses.

79 Series: Use with 791TC, 792TC, 792ST, F42 hoses.

Dimensions and pressures are for reference only and are subject to change.

### 1J779

Female Seal-Lok™ - Swivel - 45° Elbow  
ISO 12151-1 - SWE45

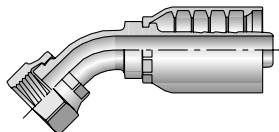

Part Number	Flange inch	Thread inch	Hose ID inch
1J779-12-12	3/4	1-3/16x12	3/4
1J779-16-16	1	1-7/16x12	1
1J779-20-20	1-1/4	1-11/16x12	1-1/4

⚠ Refer to [Section O](#) for Pressure Rating of Hose End Connections chart.

### 1J979

Female Seal-Lok™ - Swivel - 90° Elbow - Short Drop  
ISO - 12151-1 - SWES90

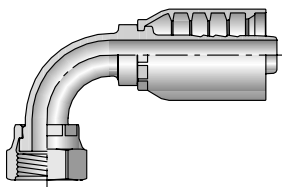

Part Number	Flange inch	Thread inch	Hose ID inch
1J979-12-12	3/4	1-3/16x12	3/4
1J979-16-16	1	1-7/16x12	1
1J979-20-20	1-1/4	1-11/16x12	1-1/4

⚠ Refer to [Section O](#) for Pressure Rating of Hose End Connections chart.

### 1JS79

Female Seal-Lok™ - Swivel - Long  
ISO 12151-1 - SWSB

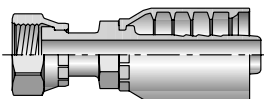

Part Number	Flange inch	Thread inch	Hose ID inch
1JS79-12-12	3/4	1-3/16x12	3/4
1JS79-16-12	1	1-7/16x12	3/4
1JS79-16-16	1	1-7/16x12	1
1JS79-20-16	1-1/4	1-11/16x12	1
1JS79-20-20	1-1/4	1-11/16x12	1-1/4
1JS79-24-24	1-1/2	2x12	1-1/2

⚠ Refer to [Section O](#) for Pressure Rating of Hose End Connections chart.

### 1XA79

Caterpillar® Flange Head

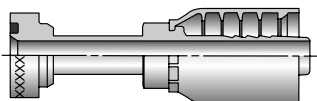

Part Number	Flange inch	Hose ID inch
1XA79-12-12	3/4	3/4
1XA79-16-16	1	1
1XA79-20-16	1-1/4	1
1XA79-20-20	1-1/4	1-1/4
1XA79-24-24	1-1/2	1-1/2

### 1XF79

Caterpillar® Flange Head - 45° Elbow

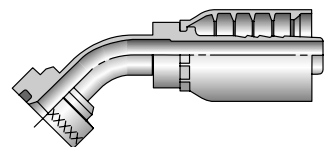

Part Number	Flange inch	Hose ID inch
1XF79-12-12	3/4	3/4
1XF79-16-16	1	1
1XF79-20-16	1-1/4	1
1XF79-20-20	1-1/4	1-1/4

### 1XN79

Caterpillar® Flange Head - 90° Elbow

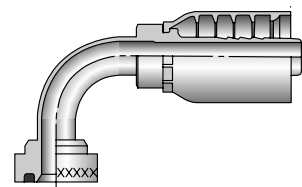

Part Number	Flange inch	Hose ID inch
1XN79-12-12	3/4	3/4
1XN79-16-16	1	1
1XN79-20-16	1-1/4	1
1XN79-20-20	1-1/4	1-1/4
1XN79-24-24	1-1/2	1-1/2

## 81 Series

### 10081

Crimp Shell



Part Number	Hose ID inch
10081-12	3/4
10081-16	1
10081-20	1-1/4
10081-24	1-1/2
10081-32	2

81 Series consists of a 10081 crimp shell and is completed by adding any 88 Series Fittings. See Equipment [Section N](#) for complete 81 Series Assembly and Crimping instructions.

79 Series: Use with 791TC, 792TC, 792ST, F42 hoses.

Dimensions and pressures are for reference only and are subject to change.

## 91N/91 Series

### 10191N

Male Taper Pipe Rigid

Part Number	Thread inch	Hose Size
10191N-2-4	1/8-27	-4
10191N-4-4	1/4-18	-4
10191N-4-5	1/4-18	-5
10191N-4-6	1/4-18	-6
10191N-6-6	3/8-18	-6
10191N-6-8	3/8-18	-8
10191N-8-8	1/2-14	-8
10191N-8-10	1/2-14	-10
10191N-8-12	1/2-14	-12
10191N-12-12	3/4-14	-12
10191N-16-16	1-11-1/2	-16
10191-20-20	1-1/4-11-1/2	-20

Construction: Brass nipple, steel shell.  
 Add "B" for Brass nipple and shell.  
 Add "C" for Stainless Steel.

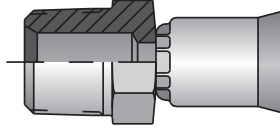

### 10391N

Male (JIC) 37°

Part Number	Thread inch	Hose Size
10391N-4-4	7/16-20	-4
10391N-5-5	1/2-20	-5
10391N-6-6	9/16-18	-6
10391N-8-6	3/4-16	-6
10391N-8-8	3/4-16	-8
10391N-10-10	7/8-14	-10
10391N-12-12	1-1/16-12	-12
10391N-16-16	1-5/16-1/2	-16

Construction: Brass nipple, steel shell.  
 Add "B" for Brass nipple and shell.  
 Add "C" for Stainless Steel.

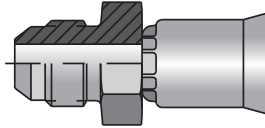

### 10691N

SAE (JIC) 37° Swivel

Part Number	Thread inch	Hose Size
10691N-4-4	7/16-20	-4
10691N-5-5	1/2-20	-5
10691N-6-6	9/16-18	-6
10691N-6-8	9/16-18	-8
10691N-8-8	3/4-16	-8
10691N-8-10	3/4-16	-10
10691N-10-10	7/8-14	-10
10691N-12-12	1-1/16-12	-12
10691N-16-16	1-5/16-12	-16
10691-20-20	1-5/8-12	-20

Construction: Brass nipple, steel nut and shell.  
 Add "B" for Brass nipple, nut and shell.  
 Add S for Steel nipple, nut and shell.  
 Add "C" for Stainless Steel.

**Note:** Sizes -4, -5, -8 and -10 incorporate a dual seat.

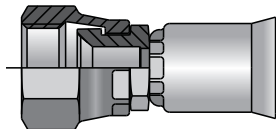

### 10791N

Female Pipe Swivel

Part Number	Thread inch	Hose Size
10791N-4-4	1/4-18	-4
10791N-6-6	3/8-18	-6
10791N-8-8	1/2-14	-8
10791N-12-12	3/4-14	-12
10791N-16-16	1-11-1/2	-16

Construction: Brass nipple, steel nut and shell.  
 Add S for Steel nipple, nut and shell.  
 Add "C" for Stainless Steel.

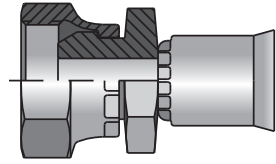

### 10891N

SAE 45° Swivel

Part Number	Thread inch	Hose Size
10891N-6-6	5/8-18	-6
10891N-12-12	1-1/16-14	-12

Construction: Brass nipple, steel nut and shell.  
 Add S for Steel nipple, nut and shell.  
 Add "C" for Stainless Steel.

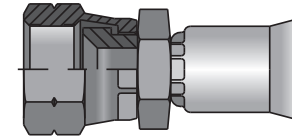

### 12891N

Male Inverted Swivel - Straight

Part Number	Thread inch	Hose Size
12891N-4-4	7/16-24	-4
12891N-5-5	1/2-20	-5
12891N-5-6	1/2-20	-6
12891N-6-6	5/8-18	-6
12891N-8-8	3/4-18	-8
12891N-10-10	7/8-18	-10
12891N-12-12	1-1/16-16	-12

Construction: Steel nipple, tube, nut and shell.  
 Add "C" for Stainless Steel.

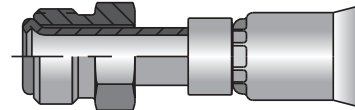

### 13491N

Straight Tube

Part Number	Hose Size
13491N-8-8	-8
13491N-8-10	-10
13491N-10-10	-10
13491N-12-12	-12

Construction: Brass nipple, steel shell.  
 Add "B" for Brass nipple and shell.  
 Add "C" for Stainless Steel.

**Note:** The 16T91N fitting includes 13491N with the 60HAB sleeve and 61HAB nut.

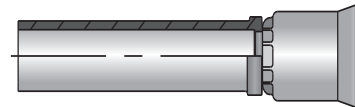

91/91N Series: Use with [919 hose](#).

Dimensions and pressures are for reference only and are subject to change.

### 13791N

JIC 37° Swivel  
45° Elbow

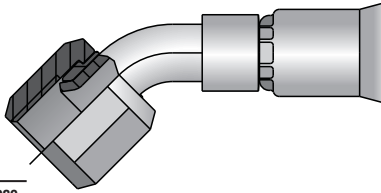

Part Number	Thread inch	Hose Size
13791N-4-4	7/16-20	-4
13791N-5-5	1/2-20	-5
13791N-6-6	9/16-18	-6
13791N-8-8	3/4-16	-8
13791N-10-10	7/8-14	-10
13791N-12-12	1-1/16-12	-12
13791N-16-16	1-5/16-12	-16
13791-20-20	1-5/8-12	-20

Construction: Steel tube, nipple, nut and shell.  
Add "C" for Stainless Steel.

### 16791N

Male Inverted Swivel  
45° Elbow

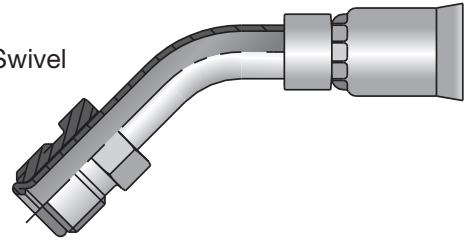

Part Number	Thread inch	Hose Size
16791N-4-4	7/16-24	-4
16791N-5-5	1/2-20	-5
16791N-6-6	5/8-18	-6
16791N-8-8	3/4-18	-8
16791N-10-10	7/8-18	-10
16791N-12-12	1-1/16-16	-12

Construction: Steel tube, nipple, nut and shell.  
Add "C" for Stainless Steel.

### 13991N

JIC 37° Swivel 90° Elbow  
Short Drop

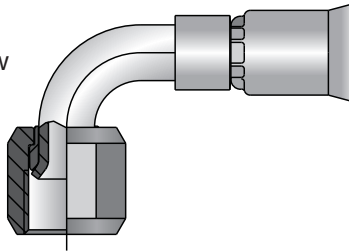

Part Number	Thread inch	Hose Size
13991N-4-4	7/16-20	-4
13991N-5-5	1/2-20	-5
13991N-6-6	9/16-18	-6
13991N-8-8	3/4-16	-8
13991N-10-10	7/8-14	-10
13991N-12-12	1-1/16-12	-12
13991N-16-16	1-5/16-12	-16
13991-20-20	1-5/8-12	-20

Construction: Steel tube, nipple, nut and shell.  
Add "C" for Stainless Steel.

### 16991N

Male Inverted Swivel  
90° Elbow

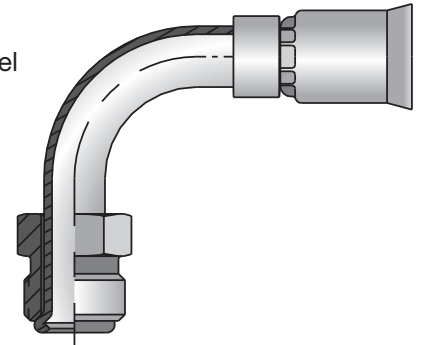

Part Number	Thread inch	Hose Size
16991N-4-4	7/16-24	-4
16991N-5-5	1/2-20	-5
16991N-5-6	1/2-20	-6
16991N-6-6	5/8-18	-6
16991N-8-8	3/4-18	-8
16991N-10-10	7/8-18	-10
16991N-12-12	1-1/16-16	-12

Construction: Steel tube, nipple, nut and shell.  
Add "C" for Stainless Steel.

### 14191N

JIC 37° Swivel 90° Elbow  
Long Drop

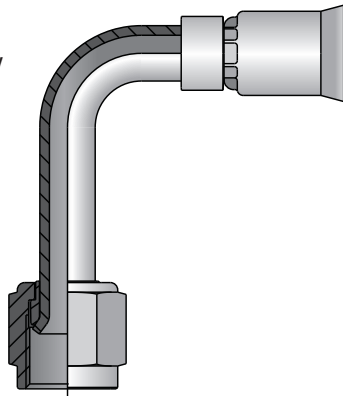

Part Number	Thread inch	Hose Size
14191N-4-4	7/16-20	-4
14191N-5-5	1/2-20	-5
14191N-6-6	9/16-18	-6
14191N-8-8	3/4-16	-8
14191N-10-10	7/8-14	-10
14191N-12-12	1-1/16-12	-12
14191N-16-16	1-5/16-12	-16
14191-20-20	1-5/8-12	-20

Construction: Steel tube, nipple, nut and shell.  
Add "C" for Stainless Steel.

91/91N Series: Use with [919 hose](#).

Dimensions and pressures are for reference only and are subject to change.

### 17791N

SAE 45° Swivel  
45° Elbow

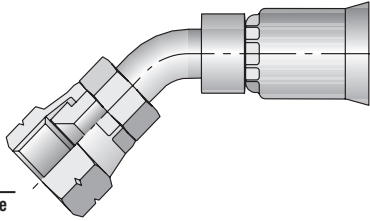

Part Number	Thread inch	Hose Size
17791N-6-6	5/8-18	3/8
17791N-12-12	1-1/16-14	3/4

Construction: Steel tube, nipple, nut and shell.  
Add "C" for Stainless Steel.

### 17991N

SAE 45° Swivel  
90° Elbow

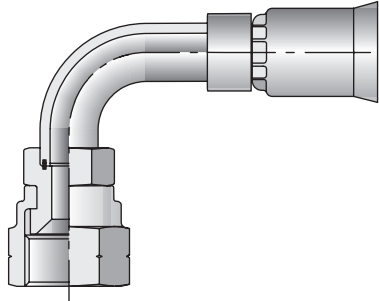

Part Number	Thread inch	Hose Size
17991N-6-6	5/8-18	3/8
17991N-12-12	1-1/16-14	3/4

Construction: Steel tube, nipple, nut and shell.  
Add "C" for Stainless Steel.

### 19291N

Female BSP Parallel  
Pipe Swivel Straight  
(60° Cone)

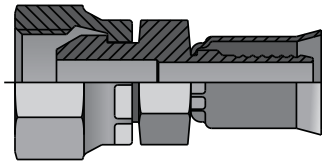

Part Number	Thread inch	Hose Size
19291N-8-8	PF-1/2-14	-8
19291N-12-12	PF-3/4-14	-12

Construction: Steel nipple, nut and shell.  
Add "B" for Brass nipple, nut and shell.  
Add "C" for Stainless Steel.

### 1B291N

Female BSP Parallel  
Pipe Swivel - 90° Elbow  
(60° Cone)

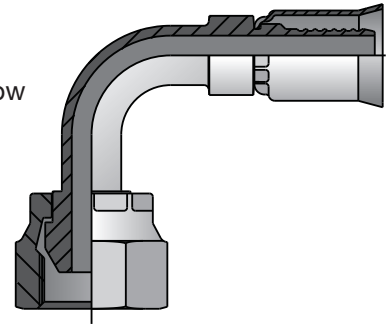

Part Number	Thread inch	Hose Size
1B291N-8-8	PF-1/2-14	-8
1B291N-12-12	PF-3/4-14	-12

Construction: Steel nipple, nut and shell.  
Add "C" for Stainless Steel.

### 1J191N

Female Seal-Lok™  
Swivel 90° Elbow  
Long Drop

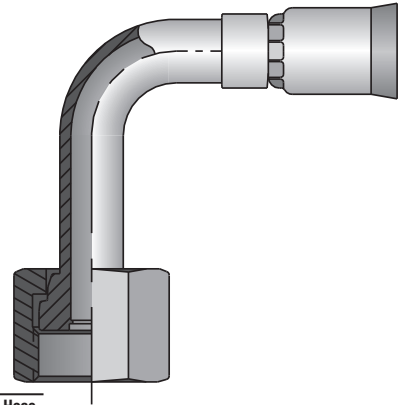

Part Number	Thread inch	Hose Size
1J191N-4-4	9/16-18	-4
1J191N-4-5	9/16-18	-5
1J191N-6-5	11/16-16	-5
1J191N-6-6	11/16-16	-6
1J191N-8-6	13/16-16	-6
1J191N-8-8	13/16-16	-8
1J191N-10-10	1-14	-10
1J191N-12-12	1-3/16-12	-12
1J191N-16-16	1-7/16-12	-16

Construction: Steel tube, nipple, nut and shell.  
Add "C" for Stainless Steel.

91/91N Series: Use with [919 hose](#).

Dimensions and pressures are for reference only and are subject to change.



### 1J791N

Female Seal-Lok™  
Swivel 45° Elbow

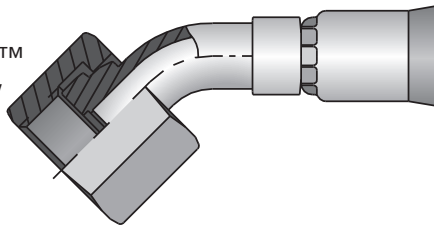

Part Number	Thread inch	Hose Size
1J791N-4-4	9/16-18	-4
1J791N-4-6	9/16-18	-6
1J791N-6-6	11/16-16	-6
1J791N-8-8	13/16-16	-8
1J791N-8-10	13/16-16	-8
1J791N-10-10	1-14	-10
1J791N-12-12	1-3/16-12	-12
1J791N-16-16	1-7/16-12	-16

Construction: Steel tube, nipple, nut and shell.  
Add "C" for Stainless Steel.

### 1J991N

Female Seal-Lok™  
Swivel 90° Elbow  
Short Drop

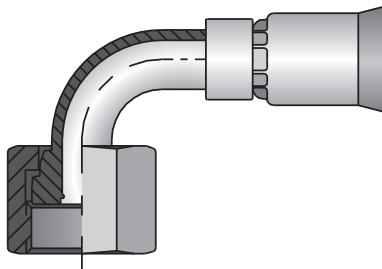

Part Number	Thread inch	Hose Size
1J991N-4-4	9/16-18	-4
1J991N-6-6	11/16-16	-6
1J991N-8-8	13/16-16	-6
1J991N-10-10	1-14	-10
1J991N-12-12	1-3/16-12	-12
1J991N-16-16	1-7/16-12	-16

Construction: Steel tube, nipple, nut and shell.  
Add "C" for Stainless Steel.

### 1JC91N

Female Seal-Lok™ Swivel  
Straight

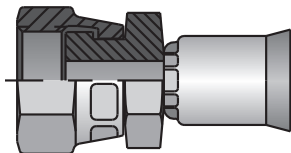

Part Number	Thread inch	Hose Size
1JC91N-4-4	9/16-18	-4
1JC91N-6-6	11/16-16	-6
1JC91N-8-8	13/16-16	-8
1JC91N-10-10	1-14	-10
1JC91N-12-10	1-3/16-12	-10
1JC91N-12-12	1-3/16-12	-12
1JC91N-16-16	1-7/16-12	-16
1JC91N-20-16	1-11/16-12	-16
1JC91-20-20	1-11/16-12	-20

Construction: Steel nipple, nut and shell.  
Add "B" for Brass nipple, nut and shell.  
Add "C" for Stainless Steel

### 1TU91N

Universal Tube Stub

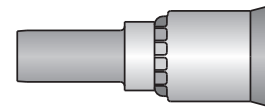

Part Number	R Dia. inch	Hose Size
1TU91-2-3C	1/8	-3
1TU91-3-3C	3/16	-3
1TU91N-4-4C	1/4	-4
1TU91N-4-5C	1/4	-5
1TU91N-6-6C	3/8	-6
1TU91N-8-8C	1/2	-8
1TU91N-8-10C	1/2	-10
1TU91N-10-10C	5/8	-10
1TU91N-12-12C	3/4	-12
1TU91N-16-16C	1	-16

Construction: Stainless Steel.

**Note:** Use with A-LOK and CPI nuts, sleeves and adapters. These components are manufactured by Parker's Instrumentation Connectors Division. Refer to catalogs 4230 & 4233 for additional information.

## 93N Series

### 10193N

Male Taper Pipe Rigid

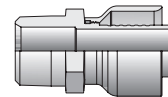

Part Number	Thread inch	Hose Size	
		inch	mm
10193N-8-8	1/2-14	1/2	13
10193N-12-12	3/4-14	3/4	19
10193N-16-16	1-11-1/2	1	25
10193N-20-20	1-1/4-11-1/2	1-1/4	32
10193N-24-24	1-1/2-11-1/2	1-1/2	38
10193N-32-32	2-11-1/2	2	51

Construction: Steel nipple, nut and shell.  
Add "C" for Stainless Steel.

### 10693N

(JIC) 37° Female Swivel

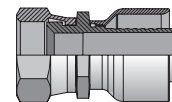

Part Number	Thread inch	Hose Size	
		inch	mm
10693N-6-6	9/16-18	3/8	10
10693N-8-8	3/4-16	1/2	13
10693N-10-10	7/8-14	5/8	16
10693N-12-12	1-1/16-12	3/4	19
10693N-16-16	1-5/16-12	1	25
10693N-20-20	1-5/8-12	1-1/4	32
10693N-24-24	1-7/8-12	1-1/2	38
10693N-32-32	2-1/2-12	2	51

Construction: Steel nipple, nut and shell.  
Add "C" for Stainless Steel.

91/91N Series: Use with [919 hose](#).

93N Series: Use with [PTFE hoses](#).

Dimensions and pressures are for reference only and are subject to change.

### 13793N

JIC 37° Swivel 45° Elbow

Part Number	Thread inch	Hose Size
13793N-12-12	1-1/16-12	-12
13793N-16-16	1-5/16-12	-16
13793N-20-20	1-5/8-12	-20
13793N-24-24	1-7/8-12	-24

Construction: Steel nipple, nut and shell.  
Add "C" for Stainless Steel.

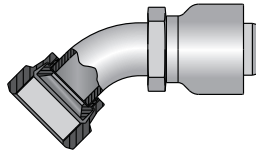

### 13993N

JIC 37° Swivel 90° Elbow Short Drop

Part Number	Thread inch	Hose Size
13993N-8-8	3/4-16	-8
13993N-10-10	7/8-14	-10
13993N-12-12	1-1/16-12	-12
13993N-16-16	1-5/16-12	-16
13993N-20-20	1-5/8-12	-20
13993N-24-24	1-7/8-12	-24

Construction: Steel nipple, nut and shell.  
Add "C" for Stainless Steel.

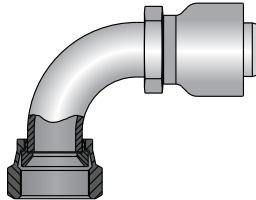

### 14K93N

ANSI B16.5 Flange

Part Number	Hose Size		Flange Diameter	
	inch	mm	inch	mm
14K93N-8-8	1/2	13	3-1/2	89
14K93N-12-12	3/4	19	3-7/8	98
14K93N-16-16	1	25	4-1/4	108
14K93N-20-20	1-1/4	32	4-5/8	117
14K93N-24-24	1-1/2	38	5	127
14K93N-32-32	2	51	6	152

Construction: Steel nipple and shell, stainless steel flange.  
**Note:** Also available in PAGE Fittings.

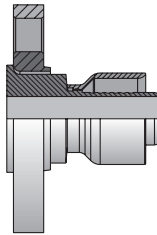

### 1J793N

Seal-Lok™ 45° Elbow

Part Number	Thread inch	Hose Size inch	Hose Size mm
1J793N-20-20	1-11/16-12	1-1/4	32

Construction: Steel nipple, tube, nut and shell.  
Add "C" for Stainless Steel.  
**Note:** Also available in PAGE Fittings.

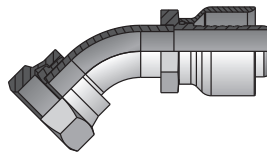

### 1J993N

Seal-Lok™ 90° Elbow Short Drop

Part Number	Thread Size	Hose Size	
		inch	mm
1J993N-20-20	1-11/16-12	1-1/4	32

Construction: Steel nipple, tube, nut and shell.  
Add "C" for Stainless Steel.  
**Note:** Also available in PAGE Fittings.

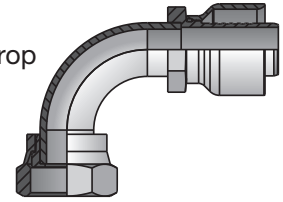

### 1JC93N

Seal-Lok™ Swivel Straight Short

Part Number	Thread inch	Hose Size	
		inch	mm
1JC93N-12-12	1-3/16-12	3/4	19
1JC93N-16-16	1-7/16-12	1	25
1JC93N-20-20	1-11/16-12	1-1/4	32

Construction: Steel nipple, nut and shell.  
Add "C" for Stainless Steel.

**Note:** Also available in PAGE Fittings. When measuring overall length to the end of the nut, B+C dimensions must be used to calculate cut-off allowance. Stainless steel fittings must be assembled with [Karykrimp2](#) or [Parkimp2](#). See [www.parker.com/crimpsource](http://www.parker.com/crimpsource) for more information.

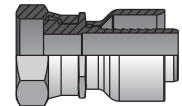

## CY Series

### 101CY

Male Taper Pipe Rigid

Part Number	Thread inch	Hose Size	
		inch	mm
101CY-2-2	1/8-27	1/8	3
101CY-2-3	1/8-27	3/16	5
101CY-4-2	1/4-18	1/8	3
101CY-4-3	1/4-18	3/16	5

Construction: Steel.  
Add "C" for Stainless Steel.

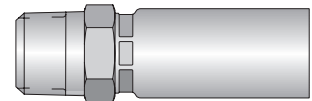

### 102CY

Female Pipe Thread

Part Number	Thread inch	Hose Size	
		inch	mm
102CY-2-3	1/8-27	3/16	5

Construction: Steel.  
Add "C" for Stainless Steel.

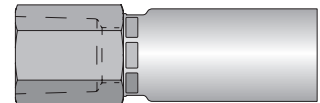

93N Series: Use with [PTFE hoses](#).  
CY Series: Use with [HLB](#), [56DH](#), [568DH](#) hoses.

Dimensions and pressures are for reference only and are subject to change.

## 106CY

Female SAE (JIC)  
37° Swivel

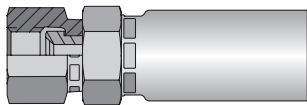

Part Number	Thread inch	Hose Size	
		inch	mm
106CY-2-2	Flare 5/16-24	1/8	3
106CY-3-2	Flare 3/8-24	1/8	3
106CY-4-2	Flare 7/16-20	1/8	3
106CY-4-3	Flare 7/16-20	3/16	5

Construction: Steel.  
Add "C" for Stainless Steel.  
**Note:** Sizes -4 incorporates a dual seat.

## 113CY

Male Pipe Swivel\*

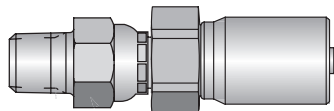

Part Number	Thread inch	Hose Size	
		inch	mm
113CY-2-2	1/8-27	1/8	3
113CY-2-3	1/8-27	3/16	3

Construction: Steel.  
Add "C" for Stainless Steel.  
**\*Note:** For use with petroleum based fluids.

**⚠ WARNING:** Fittings allow minor movement to relieve stress on hose but are not recommended for continued or extensive swiveling. Not recommended for use in CNG applications.

## 139CY

Female JIC  
37° Swivel  
90° Elbow  
Short Drop

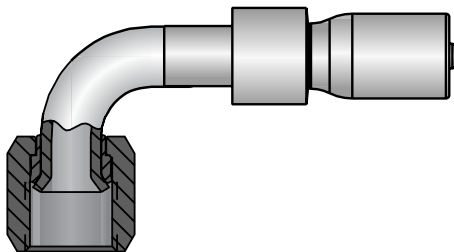

Part Number	Thread inch	Hose Size	
		inch	mm
139CY-4-2	7/16-20	1/8	3
139CY-4-3	7/16-20	3/16	5

Construction: Steel.  
Add "C" for Stainless Steel.

## 1GKCY

Bulkhead with  
Integrated Zerk Port

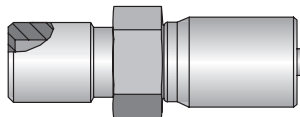

Part Number	Thread inch	Hose Size	
		inch	mm
1GKCY-2-2	1/8-27 NPSM Male w/1/4-28 UNF Female	1/8	3
1GKCY-2-3	1/8-27 NPSM Male w/1/4-28 UNF Female	3/16	5
1GKCY-2-2-L77*	1/8-27 NPSM Male w/1/4-28 UNF Female	1/8	3
1GK91N-2-4**	1/8-27 NPSM Male w/1/4-28 UNF Female	3/16	5

Construction: Steel.  
Add "C" for Stainless Steel.  
**Note:** \*Long bulkhead for use with plates under 3/4" thick. Uses 2GK-NUT, sold separately.  
\*\*Use with [919 hoses](#).

## 1J9CY

Female O-Ring Face Seal  
Swivel Short Drop

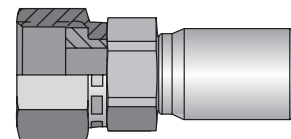

Part Number	Thread inch	Hose Size	
		inch	mm
1J9CY-4-2	9/16-18	1/8	3

Construction: Steel.  
Add "C" for Stainless Steel.

## 1JCCY

Female Seal-Lok™  
Swivel Straight  
Short

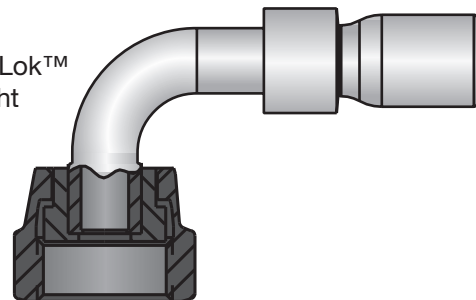

Part Number	Thread inch	Hose Size	
		inch	mm
1JCCY-4-2	9/16-18	1/8	3

Construction: Steel.  
Add "C" for Stainless Steel.

## 1LMCY

Male Grease

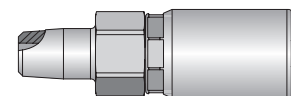

Part Number	Thread Size	Hose ID	
		inch	mm
1LMCY-2-2	1/4-28	1/8	3

Construction: Steel.  
Add "C" for Stainless Steel.

CY Series: Use with [HLB](#), [56DH](#), [568DH](#) hoses.

Dimensions and pressures are for reference only and are subject to change.

## HY Series

### 101HY

Male NPTF Pipe - Rigid

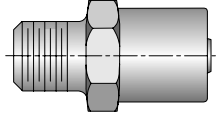

Part Number	Thread inch	Hose ID inch
101HY-2-4	1/8x27	1/4
101HY-4-4	1/4x18	1/4
101HY-4-5	1/4x18	5/16
101HY-4-6	1/4x18	3/8
101HY-6-4	3/8x18	1/4
101HY-6-5	3/8x18	5/16
101HY-6-6	3/8x18	3/8
101HY-6-8	3/8x18	1/2
101HY-8-4	1/2x14	1/4
101HY-8-6	1/2x14	3/8
101HY-8-7	1/2x14	13/32
101HY-8-8	1/2x14	1/2
101HY-8-10	1/2x14	5/8
101HY-8-12	1/2x14	3/4
101HY-12-8	3/4x14	1/2
101HY-12-10	3/4x14	5/8
101HY-12-12	3/4x14	3/4
101HY-12-16	3/4x14	1
101HY-16-12	1x11-1/2	3/4
101HY-16-14	1x11-1/2	7/8
101HY-16-16	1x11-1/2	1
101HY-20-20	1-1/4x11-1/2	1-1/4

Stainless steel fittings must be assembled with [Karrykrimp 2](#), [Phastkrimp](#), [Superkrimp](#) or [Parkrimp 2](#). See [www.parker.com/crimpsource](http://www.parker.com/crimpsource) for more information.

### 102HY

Female NPTF Pipe - Rigid

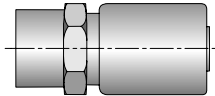

Part Number	Thread inch	Hose ID inch
102HY-2-4	1/8x27	1/4
102HY-4-4	1/4x18	1/4
102HY-4-6	1/4x18	3/8
102HY-6-4	3/8x18	1/4
102HY-6-6	3/8x18	3/8
102HY-8-6	1/2x14	3/8
102HY-8-8	1/2x14	1/2
102HY-12-12	3/4x14	3/4
102HY-16-16	1x11-1/2	1

### 103HY

Male JIC 37° - Rigid

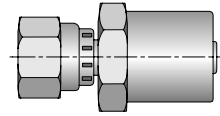

Part Number	Thread inch	Hose ID inch
103HY-4-4	7/16x20	1/4
103HY-5-4	1/2x20	1/4
103HY-6-4	9/16x18	1/4
103HY-6-5	9/16x18	5/16
103HY-6-6	9/16x18	3/8
103HY-6-8	9/16x18	1/2
103HY-8-6	3/4x16	3/8
103HY-8-8	3/4x16	1/2
103HY-10-6	7/8x14	3/8
103HY-10-8	7/8x14	1/2
103HY-10-10	7/8x14	5/8
103HY-10-12	7/8x14	3/4
103HY-12-8	1-1/16x12	1/2
103HY-12-10	1-1/16x12	5/8
103HY-12-12	1-1/16x12	3/4
103HY-14-12	1-3/16x12	3/4
103HY-16-12	1-5/16x12	3/4
103HY-16-16	1-5/16x12	1
103HY-20-16	1-5/8x12	1
103HY-20-20	1-5/8x12	1-1/4

### 105HY

Male SAE Straight Thread with O-Ring - Rigid

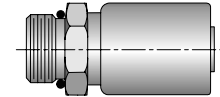

Part Number	Thread inch	Hose ID inch
105HY-4-4	7/16x20	1/4
105HY-5-4	1/2x20	1/4
105HY-6-4	9/16x18	1/4
105HY-6-6	9/16x18	3/8
105HY-8-6	3/4x16	3/8
105HY-8-8	3/4x16	1/2
105HY-10-6	7/8x14	3/8
105HY-10-8	7/8x14	1/2
105HY-10-10	7/8x14	5/8
105HY-12-8	1-1/16x12	1/2
105HY-12-10	1-1/16x12	5/8
105HY-12-12	1-1/16x12	3/4
105HY-16-12	1-5/16x12	3/4
105HY-16-16	1-5/16x12	1

O-Ring not compatible with Phosphate Ester fluids.

HY Series: Use with [AX](#), [BXX](#), [S4](#), [S5](#), [S6](#) and [S9](#) hoses.

Dimensions and pressures are for reference only and are subject to change.

## 106HY

Female JIC 37° - Swivel

Part Number	Thread inch	Hose ID inch
106HY-3-4	3/8x24	1/4
106HY-4-4	7/16x20	1/4
106HY-4-6	7/16x20	3/8
106HY-5-4	1/2x20	1/4
106HY-5-5	1/2x20	5/16
106HY-5-6	1/2x20	3/8
106HY-6-4	9/16x18	1/4
106HY-6-5	9/16x18	5/16
106HY-6-6	9/16x18	3/8
106HY-8-6	3/4x16	3/8
106HY-8-8	3/4x16	1/2
106HY-8-10	3/4x16	5/8
106HY-8-12	3/4x16	3/4
106HY-10-6	7/8x14	3/8
106HY-10-8	7/8x14	1/2
106HY-10-10	7/8x14	5/8
106HY-10-12	7/8x14	3/4
106HY-12-6	1-1/16x12	3/8
106HY-12-8	1-1/16x12	1/2
106HY-12-10	1-1/16x12	5/8
106HY-12-12	1-1/16x12	3/4
106HY-12-16	1-1/16x12	1
106HY-14-12	1-3/16x12	3/4
106HY-16-12	1-5/16x12	3/4
106HY-16-14	1-5/16x12	7/8
106HY-16-16	1-5/16x12	1
106HY-16-20	1-5/16x12	1-1/4
106HY-20-16	1-5/8x12	1
106HY-20-20	1-5/8x12	1-1/4

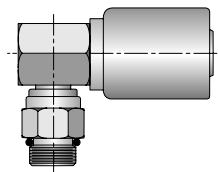

Stainless steel fittings must be assembled with [Karrykrimp 2](#), [PHastkrimp](#), [Superkrimp](#) or [Parkrimp 2](#).  
See [www.parker.com/crimpsource](http://www.parker.com/crimpsource) for more information.

## 107HY

Female NPSM Pipe - Swivel - (60° Cone)

Part Number	Thread inch	Hose ID inch
107HY-4-4	1/4x18	1/4
107HY-6-4	3/8x18	1/4
107HY-6-6	3/8x18	3/8
107HY-8-8	1/2x14	1/2
107HY-12-8	3/4x14	1/2
107HY-12-12	3/4x14	3/4
107HY-16-16	1x11-1/2	1

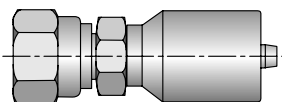

## 108HY

Female SAE 45° - Swivel

Part Number	Thread inch	Hose ID inch
108HY-4-4	7/16x20	1/4
108HY-5-4	1/2x20	1/4
108HY-5-5	1/2x20	5/16
108HY-6-4	5/8x18	1/4
108HY-6-5	5/8x18	5/16
108HY-6-6	5/8x18	3/8
108HY-8-6	3/4x16	3/8
108HY-8-8	3/4x16	1/2
108HY-8-12	3/4x16	3/4
108HY-10-8	7/8x14	1/2
108HY-10-10	7/8x14	5/8
108HY-12-10	1-1/16x12	5/8
108HY-12-12	1-1/16x12	3/4

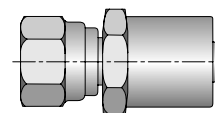

## 10GHY

Male SAE Straight Thread with O-Ring - Swivel

Part Number	Thread inch	Hose ID inch
10GHY-4-4	7/16x20	1/4
10GHY-5-4	1/2x20	1/4
10GHY-6-4	9/16x18	1/4
10GHY-6-6	9/16x18	3/8
10GHY-8-6	3/4x16	3/8
10GHY-8-8	3/4x16	1/2
10GHY-10-8	7/8x14	1/2
10GHY-12-8	1-1/16x12	1/2
10GHY-12-12	1-1/16x12	3/4
10GHY-16-16	1-5/16x12	1

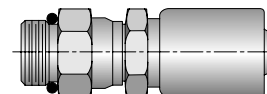

Fitting allows minor movement under pressure to relieve stress on hose but is not to be used on extensive or continuous swiveling.  
O-Ring not compatible with Phosphate Ester fluids.

## 10LHY

Male SAE Straight Thread with O-Ring - Swivel - 90° Elbow

Part Number	Thread inch	Hose ID inch
10LHY-4-4	7/16x20	1/4
10LHY-6-4	9/16x18	1/4
10LHY-6-6	9/16x18	3/8
10LHY-8-4	3/4x16	1/4
10LHY-8-6	3/4x16	3/8
10LHY-8-8	3/4x16	1/2
10LHY-10-8	7/8x14	1/2
10LHY-12-12	1-1/16x12	3/4

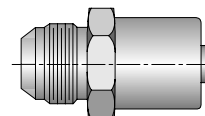

Fitting allows minor movement under pressure to relieve stress on hose but is not to be used on extensive or continuous swiveling.

HY Series: Use with [AX](#), [BXX](#), [S4](#), [S5](#), [S6](#) and [S9](#) hoses.

Dimensions and pressures are for reference only and are subject to change.

### 111HY

Male Ferulok Flareless - Rigid  
(24° Cone w/Nut and Ferrule)

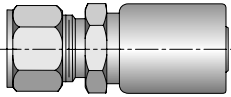

Part Number	Thread inch	Hose ID inch
111HY-4-4	7/16x20	1/4
111HY-4-6	7/16x20	3/8
111HY-5-6	1/2x20	3/8
111HY-6-4	9/16x18	1/4
111HY-6-6	9/16x18	3/8
111HY-8-6	3/4x16	3/8
111HY-8-8	3/4x16	1/2
111HY-10-8	7/8x14	1/2
111HY-12-12	1-1/16x12	3/4

The Parker Ferrule-Fix fitting makes it possible to salvage the bent tube section from a hose assembly for quick, easy on the job repairs. For additional information see Ferrule-Fix installation instructions in [Section N](#).

### 113HY

Male NPTF Pipe - Swivel

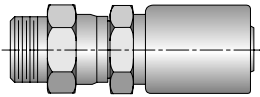

Part Number	Thread inch	Hose ID inch
113HY-2-4	1/8x27	1/4
113HY-4-4	1/4x18	1/4
113HY-4-6	1/4x18	3/8
113HY-6-4	3/8x18	1/4
113HY-6-6	3/8x18	3/8
113HY-6-8	3/8x18	1/2
113HY-8-6	1/2x14	3/8
113HY-8-8	1/2x14	1/2
113HY-12-12	3/4x14	3/4
113HY-16-16	1x11-1/2	1

Fitting allows minor movement under pressure to relieve stress on hose but is not to be used for continuous swiveling. See [Section O](#) for Pressure Limitations.

### 11LHY

Male NPTF Pipe - Swivel -  
90° Elbow

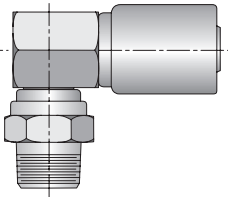

Part Number	Thread inch	Hose ID inch
11LHY-2-4	1/8x27	1/4
11LHY-4-4	1/4x18	1/4
11LHY-4-6	1/4x18	3/8
11LHY-6-4	3/8x18	1/4
11LHY-6-6	3/8x18	3/8
11LHY-8-6	1/2x14	3/8
11LHY-8-8	1/2x14	1/2

### 128HY

Male Inverted SAE 45° -  
Swivel

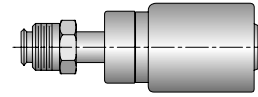

Part Number	Thread inch	Hose ID inch
128HY-3-4	3/8x24	1/4
128HY-4-4	7/16x24	1/4
128HY-5-4	1/2x20	1/4
128HY-5-6	1/2x20	3/8
128HY-6-5	5/8x18	5/16
128HY-6-6	5/8x18	3/8
128HY-7-6	11/16x18	3/8
128HY-8-6	3/4x18	3/8
128HY-8-8	3/4x18	1/2

### 129HY

Female Inverted SAE 45° -  
Rigid

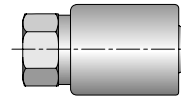

Part Number	Thread inch	Hose ID inch
129HY-5-4	1/2x20	1/4
129HY-6-6	5/8x18	3/8

### 137HY

Female JIC 37° - Swivel -  
45° Elbow - Short Drop

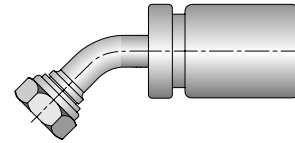

Part Number	Thread inch	Hose ID inch
137HY-4-4	7/16x20	1/4
137HY-5-4	1/2x20	1/4
137HY-6-4	9/16x18	1/4
137HY-6-5	9/16x18	5/16
137HY-6-6	9/16x18	3/8
137HY-8-6	3/4x16	3/8
137HY-8-8	3/4x16	1/2
137HY-10-8	7/8x14	1/2
137HY-10-10	7/8x14	5/8
137HY-12-10	1-1/16x12	5/8
137HY-12-12	1-1/16x12	3/4
137HY-16-12	1-5/16x12	3/4
137HY-16-16	1-5/16x12	1

### 134HY

Male Standpipe - Rigid -  
(Inch Size Tube O.D.)

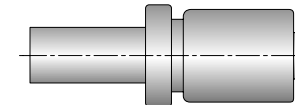

Part Number	R inch	Hose ID inch
134HY-6-6	3/8	3/8
134HY-8-6	1/2	3/8
134HY-12-12	3/4	3/4

HY Series: Use with [AX](#), [BXX](#), [S4](#), [S5](#), [S6](#) and [S9](#) hoses.

Dimensions and pressures are for reference only and are subject to change.

### 139HY

Female JIC 37° - Swivel - 90° Elbow - Short Drop

Part Number	Thread inch	Hose ID inch
139HY-4-4	7/16x20	1/4
139HY-5-4	1/2x20	1/4
139HY-6-4	9/16x18	1/4
139HY-6-5	9/16x18	5/16
139HY-6-6	9/16x18	3/8
139HY-6-8	9/16x18	1/2
139HY-8-6	3/4x16	3/8
139HY-8-8	3/4x16	1/2
139HY-10-8	7/8x14	1/2
139HY-10-10	7/8x14	5/8
139HY-10-12	7/8x14	3/4
139HY-12-8	1-1/16x12	1/2
139HY-12-10	1-1/16x12	5/8
139HY-12-12	1-1/16x12	3/4
139HY-16-12	1-5/16x12	3/4
139HY-16-16	1-5/16x12	1

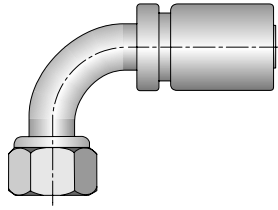

### 167HY

Male Inverted SAE 45° - Swivel - 45° Elbow

Part Number	Thread inch	Hose ID inch
167HY-4-4	7/16x24	1/4
167HY-5-4	1/2x20	1/4
167HY-5-6	1/2x20	3/8
167HY-6-6	5/8x18	3/8
167HY-8-8	3/4x18	1/2

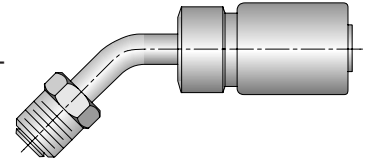

### 169HY

Male Inverted SAE 45° - Swivel - 90° Elbow

Part Number	Thread inch	Hose ID inch
169HY-3-4	3/8x24	1/4
169HY-4-4	7/16x24	1/4
169HY-4-6	7/16x24	3/8
169HY-5-4	1/2x20	1/4
169HY-5-6	1/2x20	3/8
169HY-6-5	5/8x18	5/16
169HY-6-6	5/8x18	3/8
169HY-7-6	11/16x18	3/8
169HY-8-8	3/4x18	1/2

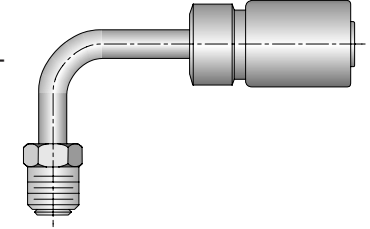

### 13DHY

Male Standpipe Metric S - Rigid

End Connection per ISO 8434-1-SDS

Part Number	R mm	Hose ID inch
13DHY-16-8	16	1/2
13DHY-30-16	30	1

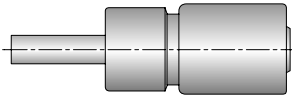

### 177HY

Female SAE 45° - Swivel - 45° Elbow

Part Number	Thread inch	Hose ID inch
177HY-6-6	5/8x18	3/8
177HY-12-12	1-1/16x14	3/4

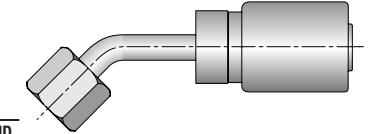

### 141HY

Female JIC 37° - Swivel - 90° Elbow - Long Drop

Part Number	Thread inch	Hose ID inch
139HY-4-4	7/16x20	1/4
139HY-5-4	1/2x20	1/4
139HY-6-4	9/16x18	1/4
139HY-6-5	9/16x18	5/16
139HY-6-6	9/16x18	3/8
139HY-6-8	9/16x18	1/2
139HY-8-6	3/4x16	3/8
139HY-8-8	3/4x16	1/2
139HY-10-8	7/8x14	1/2
139HY-10-10	7/8x14	5/8
139HY-10-12	7/8x14	3/4
139HY-12-8	1-1/16x12	1/2
139HY-12-10	1-1/16x12	5/8
139HY-12-12	1-1/16x12	3/4
139HY-16-12	1-5/16x12	3/4
139HY-16-16	1-5/16x12	1

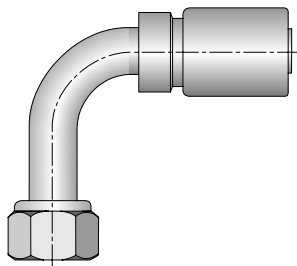

### 179HY

Female SAE 45° - Swivel - 90° Elbow

Part Number	Thread inch	Hose ID inch
179HY-6-5	5/8x18	5/16
179HY-6-6	5/8x18	3/8
179HY-12-12	1-1/16x14	3/4

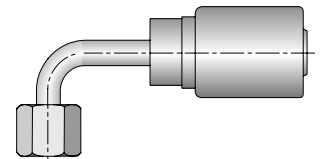

### 193HY

Female JIC 37° - Swivel - 90° Elbow - (Block Type)

Part Number	Thread inch	Hose ID inch
193HY-6-6	9/16x18	3/8
193HY-8-6	3/4x16	3/8
193HY-8-8	3/4x16	1/2
193HY-12-12	1-1/16x12	3/4

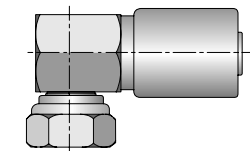

HY Series: Use with AX, BXX, S4, S5, S6 and S9 hoses.

Dimensions and pressures are for reference only and are subject to change.

### 1D0HY

Male Metric L - Rigid -  
(24° Cone)  
ISO 12151-2

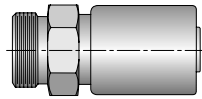

Part Number	Thread mm	Hose ID inch
1D0HY-6-4	6 M12x1.5	1/4
1D0HY-8-4	8 M14x1.5	1/4
1D0HY-10-4	10 M16x1.5	1/4
1D0HY-10-6	10 M16x1.5	3/8
1D0HY-12-6	12 M18x1.5	3/8
1D0HY-15-6	15 M22x1.5	3/8
1D0HY-15-8	15 M22x1.5	1/2
1D0HY-18-10	18 M26x1.5	5/8

### 1D9HY

Male BSP Parallel Pipe -  
Rigid - (60° Cone)  
ISO 228-1

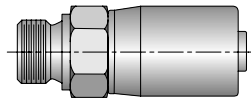

Part Number	Thread inch	Hose ID inch
1D9HY-4-4	1/4x19	1/4
1D9HY-6-6	3/8x19	3/8
1D9HY-8-6	1/2x14	3/8
1D9HY-8-8	1/2x14	1/2

When used in a port, a bonded seal must be used.

### 1GJHY

Female Grease Connection -  
SPL - PTF Taper Thread -  
Rigid - 1/2x27

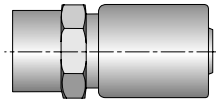

Part Number	Thread inch	Hose ID inch
1GJHY-8-4	1/2x27	1/4

### 1GUHY

Female BSP Parallel Pipe -  
Swivel - (60° Cone)  
ISO 228-1

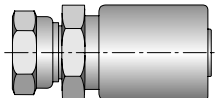

Part Number	Thread inch	Hose ID inch
1GUHY-4-4	1/4x19	1/4
1GUHY-6-4	3/8x19	1/4
1GUHY-6-6	3/8x19	3/8
1GUHY-8-6	1/2x14	3/8
1GUHY-8-8	1/2x14	1/2
1GUHY-12-12	3/4x14	3/4
1GUHY-16-16	1x11	1

### 1J0HY

Male Seal-Lok™ - Rigid -  
(with O-Ring)  
ISO 1215-1 - S

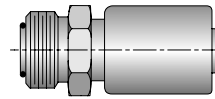

Part Number	Thread inch	Hose ID inch
1J0HY-4-4	9/16x18	1/4
1J0HY-6-6	11/16x16	3/8
1J0HY-8-8	13/16x16	1/2
1J0HY-12-8	1-3/16x12	1/2

### 1J1HY

Female Seal-Lok™ - Swivel -  
90° Elbow - Long Drop  
ISO 12151-1 - SWEL90

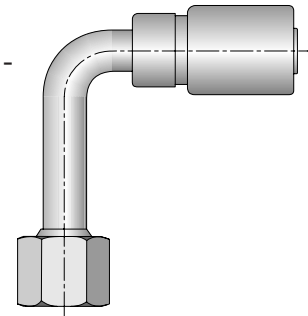

Part Number	Thread inch	Hose ID inch
1J1HY-4-4	9/16x18	1/4
1J1HY-6-4	11/16x16	1/4
1J1HY-6-6	11/16x16	3/8
1J1HY-8-6	13/16x16	3/8
1J1HY-8-8	13/16x16	1/2
1J1HY-10-8	1x14	1/2
1J1HY-10-10	1x14	5/8
1J1HY-12-12	1-3/16x12	3/4
1J1HY-16-16	1-7/16x12	1

### 1J7HY

Female Seal-Lok™ -  
Swivel - 45° Elbow  
ISO 12151-1 - SWE45

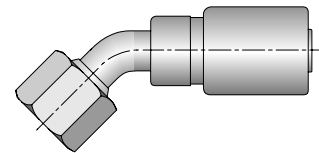

Part Number	Thread inch	Hose ID inch
1J7HY-4-4	9/16x18	1/4
1J7HY-6-4	11/16x16	1/4
1J7HY-6-6	11/16x16	3/8
1J7HY-6-8	11/16x16	1/2
1J7HY-8-4	13/16x16	1/4
1J7HY-8-6	13/16x16	3/8
1J7HY-8-8	13/16x16	1/2
1J7HY-10-8	1x14	1/2
1J7HY-10-10	1x14	5/8
1J7HY-10-12	1x14	3/4
1J7HY-12-10	1-3/16x12	5/8
1J7HY-12-12	1-3/16x12	3/4
1J7HY-16-12	1-7/16x12	3/4
1J7HY-16-16	1-7/16x12	1

HY Series: Use with AX, BXX, S4, S5, S6 and S9 hoses.

Dimensions and pressures are for reference only and are subject to change.



## 1J9HY

Female Seal-Lok™ -  
Swivel - 90° Elbow -  
Short Drop  
ISO 12151-1 - SWES90

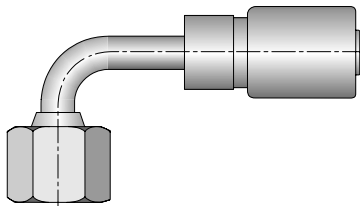

Part Number	Thread inch	Hose ID inch
1J9HY-4-4	9/16x18	1/4
1J9HY-4-6	9/16x18	3/8
1J9HY-6-4	11/16x16	1/4
1J9HY-6-5	11/16x16	5/16
1J9HY-6-6	11/16x16	3/8
1J9HY-6-8	11/16x16	1/2
1J9HY-8-6	13/16x16	3/8
1J9HY-8-8	13/16x16	1/2
1J9HY-10-8	1x14	1/2
1J9HY-10-10	1x14	5/8
1J9HY-10-12	1x14	3/4
1J9HY-12-8	1-3/16x12	1/2
1J9HY-12-10	1-3/16x12	5/8
1J9HY-12-12	1-3/16x12	3/4
1J9HY-16-12	1-7/16x12	3/4
1J9HY-16-16	1-7/16x12	1
1J9HY-20-16	1-11/16x12	1

## 1JCHY

Female Seal-Lok™ -  
Swivel - Short  
ISO 12151-1 - SWSA

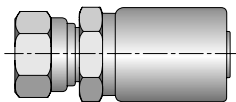

Part Number	Thread inch	Hose ID inch
1JCHY-4-4	9/16x18	1/4
1JCHY-6-6	11/16x16	3/8
1JCHY-8-8	13/16x16	1/2
1JCHY-12-12	1-3/16x12	3/4

## 1JSHY

Female Seal-Lok™ -  
Swivel - Long  
ISO 12151-1 - SWSB

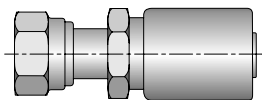

Part Number	Thread inch	Hose ID inch
1JSHY-4-4	9/16x18	1/4
1JSHY-6-4	11/16x16	1/4
1JSHY-6-5	11/16x16	5/16
1JSHY-6-6	11/16x16	3/8
1JSHY-8-6	13/16x16	3/8
1JSHY-8-8	13/16x16	1/2
1JSHY-10-8	1x14	1/2
1JSHY-10-10	1x14	5/8
1JSHY-10-12	1x14	3/4
1JSHY-12-10	1-3/16x12	5/8
1JSHY-12-12	1-3/16x12	3/4
1JSHY-16-12	1-7/16x12	3/4
1JSHY-16-16	1-7/16x12	1
1JSHY-20-16	1-11/16x12	1
1JSHY-20-20	1-11/16x12	1-1/4

## 1UTHY

Male BSP Taper Pipe -  
Rigid - (60° Cone)

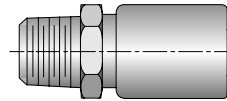

Part Number	Thread inch	Hose ID inch
1UTHY-2-4	1/8x28	1/4
1UTHY-4-4	1/4x19	1/4

## 1XUHY

Female Metric Swivel -  
(30° Flare)

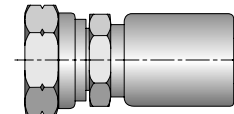

Part Number	Thread mm	Hose ID inch
1XUHY-24-8	24 M24x1.5	1/2
1XUHY-24-10	24 M24x1.5	5/8
1XUHY-30-12	30 M30x1.5	3/4
1XUHY-33-16	33 M33x1.5	1

## SF Series

### 101SF

Male Taper Pipe Rigid

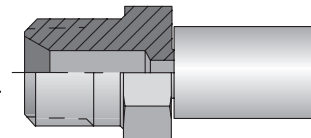

Part Number	Thread inch	Hose Size inch	mm
101SF-2-1	1/8-27	.090	2.3

Construction: Steel

### 106SF

JIC 37° Swivel

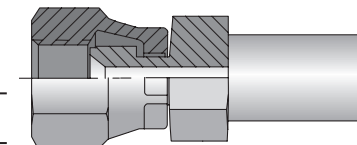

Part Number	Thread inch	Hose Size inch	mm
106SF-2-1	5/16-24	.090	2.3

Construction: Steel

### 1JBSF

Male Seal-Lok™  
Bulkhead with O-Ring

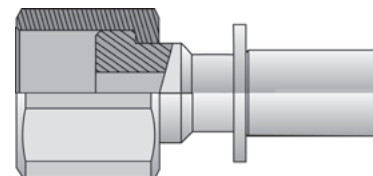

Part Number	Thread inch	Hose Size inch	mm
1JBSF-4-1	9/16-18	.090	2.3

Construction: Steel

**Note:** Bulkhead Locknut sold separately.  
WLN Locknuts are Manufactured by the  
Tube Fittings Division. Refer to Catalog 4300  
for additional information.

HY Series: Use with AX, BXX, S4, S5, S6 and S9 hoses.

SF Series: Use with 56DH and 568DH hoses.

Dimensions and pressures are for reference only and are subject to change.

# 1JSSF

Female Seal-Lok™ Swivel Long

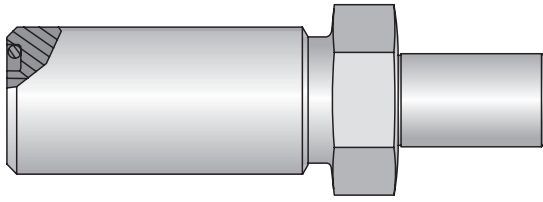

Part Number	Thread inch	Hose Size	
		inch	mm
1JSSF-4-1	9/16-18	.090	2.3

Construction: Steel



SF Series: Use with [56DH](#) and [568DH](#) hoses.

Dimensions and pressures are for reference only and are subject to change.